

Python for Informatics
Exploring Data

Charles Severance

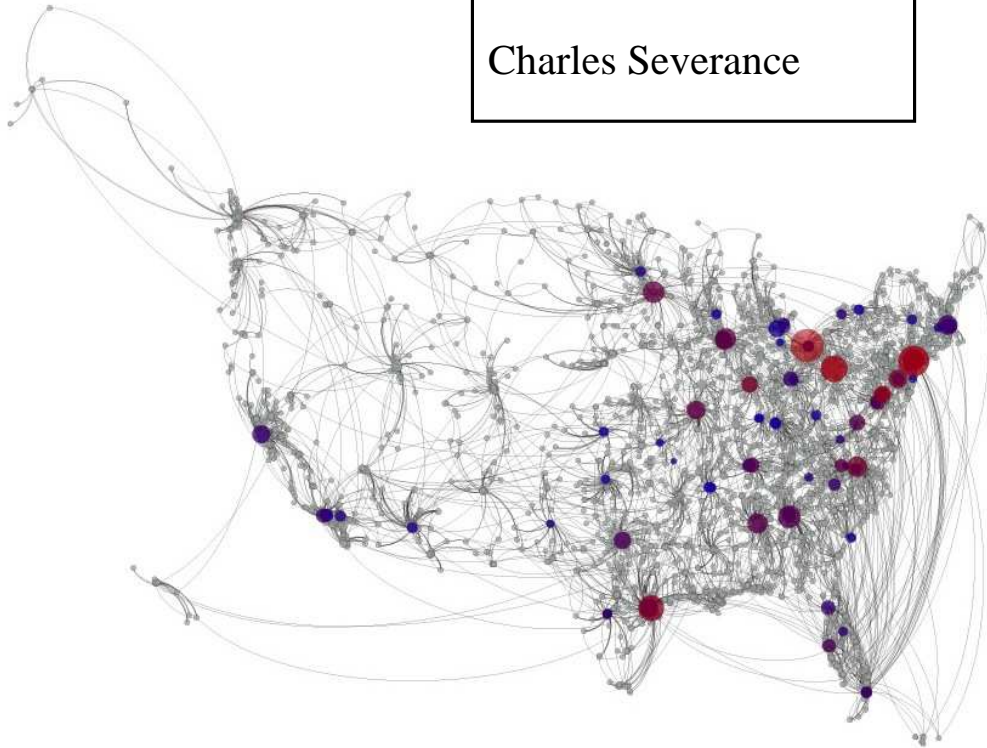

Python for Informatics

Exploring Information

Version 0.0.3

Charles Severance



Copyright © 2009, 2010 Charles Severance.

Printing history:

December 2009: Begin to produce *Python for Informatics: Exploring Information* by re-mixing *Think Python: How to Think Like a Computer Scientist*

June 2008: Major revision, changed title to *Think Python: How to Think Like a Computer Scientist*.

August 2007: Major revision, changed title to *How to Think Like a (Python) Programmer*.

April 2002: First edition of *How to Think Like a Computer Scientist*.

This work is licensed under a Creative Commons Attribution-Share Alike 3.0 Unported License. This license is available at creativecommons.org/licenses/by-sa/3.0/.

The original form of this book is \LaTeX source code. Compiling this \LaTeX source has the effect of generating a device-independent representation of a textbook, which can be converted to other formats and printed.

The \LaTeX source for the *Think Python: How to Think Like a Computer Scientist* version of this book is available from <http://www.thinkpython.com>.

The \LaTeX source for the *Python for Informatics: Exploring Information* version of the book is available (for the moment) from <http://source.sakaiproject.org/contrib//csev/trunk/pyinf/>.

The cover images were provided by Dr. Lada Adamic and are used with permission.

Preface

Python for Informatics: Remixing an Open Book

It is quite natural for academics who are continuously told to “publish or perish” to want to always create something from scratch that is their own fresh creation. This book is an experiment in not starting from scratch, but instead “re-mixing” the book titled *Think Python: How to Think Like a Computer Scientist* written by Allen B. Downey, Jeff Elkner and others.

In December of 2009, I was preparing to teach **SI502 - Networked Programming** at the University of Michigan for the fifth semester in a row and decided it was time to write a Python textbook that focused on exploring data instead of understanding algorithms and abstractions. My goal in SI502 is to teach people life-long data handling skills using Python. Few of my students were planning to be professional computer programmers. Instead, they planned be librarians, managers, lawyers, biologists, economists, etc. who happened to want to skillfully use technology in their chosen field.

I never seemed to find the perfect data-oriented Python book for my course so I set out to write just such a book. Luckily at a faculty meeting three weeks before I was about to start my new book from scratch over the holiday break, Dr. Atul Prakash showed me the *Think Python* book which he had used to teach his Python course that semester. It is a well-written Computer Science text with a focus on short, direct explanations and ease of learning.

As the copyright holder of *Think Python*, Allen has given me permission to change the book’s license from the GNU Free Documentation License to the more recent Creative Commons Attribution — Share Alike license. This follows a general shift in open documentation licenses moving from the GFDL to the CC-BY-SA (i.e. Wikipedia). Using the CC-BY-SA license maintains the book’s strong copyleft tradition while making it even more straightforward for new authors to reuse this material as they see fit.

I expect that by the time I am done with *Python for Informatics* over fifty percent of the book will be new. The overall structure will be changed to get to doing data analysis problems as quickly as possible and have a series of running examples and exercises about data analysis. Then I will add chapters on regular expressions, data visualization, working with spreadsheet data, structured query language using SQLite, web scraping, and calling REST-based Application Program Interfaces.

The ultimate goal in the shift from a Computer Science to an Informatics focus is to pull topics into the first programming class that can be applied even if one chooses not to become a professional programmer.

What is interesting even with this change of focus is how much of the original *Think Python* book material is directly relevant to this book and how much will fit right into *Python for Informatics* with virtually no change.

By starting with the *Think Python* book, I don't have to write the basic descriptions of the Python language or how to debug programs and instead focus on the topical material that is the value-add of *Python for Informatics*.

Students who find this book interesting and want to further explore a career as a professional programmer should probably look at the *Think Python* book. Because there is a lot of overlap between the two books, you will quickly pick up skills in the additional areas of Computer Science which are covered in *Think Python*. And given that the books have a similar writing style and at times have identical text and examples, you should be able to pick up these new topics with a minimum of effort.

I hope that this book serves an example of why open materials are so important to the future of education, and want to thank Allen B. Downey and Cambridge University Press for their forward looking decision to make the book available under an open Copyright. I hope they are pleased with the results of my efforts and I hope that you the reader are pleased with *our* collective efforts.

Charles Severance
www.dr-chuck.com
December 19, 2009

Charles Severance is a Clinical Assistant Professor at the University of Michigan School of Information.

Draft Version Instructions

The copy of this book you are looking at is currently a draft and still in development. The general roadmap for the rest of the development book is as follows:

- Teach SI502 - Networked Programming at University of Michigan Winter 2010. The first 10 chapters of the book will be used for the first four weeks of the course. At least three more chapters will be written for SI502 and distributed during the semester that line up with the topics in the second half of SI502 (Networked Programming, Databases, and Using Web Services).
- There are four more chapters planned at some point (Advanced Functions, Regular Expressions, Automating Common Tasks, and Visualizing data). These are not currently in the scope of SI502 for Winter 2010.

Like all books being written and used in a course at the same time, student feedback is essential to producing a strong book. So I hope that students will look at the book and

help me find simple errors, places where ideas jump too fast, improvements in the glossary, debugging, and exercises in each chapter.

You can also send comments to csev (at) umich.edu at any time.

Thanks in advance for your patience and assistance.

Preface for “Think Python”

The strange history of “Think Python”

(Allen B. Downey)

In January 1999 I was preparing to teach an introductory programming class in Java. I had taught it three times and I was getting frustrated. The failure rate in the class was too high and, even for students who succeeded, the overall level of achievement was too low.

One of the problems I saw was the books. They were too big, with too much unnecessary detail about Java, and not enough high-level guidance about how to program. And they all suffered from the trap door effect: they would start out easy, proceed gradually, and then somewhere around Chapter 5 the bottom would fall out. The students would get too much new material, too fast, and I would spend the rest of the semester picking up the pieces.

Two weeks before the first day of classes, I decided to write my own book. My goals were:

- Keep it short. It is better for students to read 10 pages than not read 50 pages.
- Be careful with vocabulary. I tried to minimize the jargon and define each term at first use.
- Build gradually. To avoid trap doors, I took the most difficult topics and split them into a series of small steps.
- Focus on programming, not the programming language. I included the minimum useful subset of Java and left out the rest.

I needed a title, so on a whim I chose *How to Think Like a Computer Scientist*.

My first version was rough, but it worked. Students did the reading, and they understood enough that I could spend class time on the hard topics, the interesting topics and (most important) letting the students practice.

I released the book under the GNU Free Documentation License, which allows users to copy, modify, and distribute the book.

What happened next is the cool part. Jeff Elkner, a high school teacher in Virginia, adopted my book and translated it into Python. He sent me a copy of his translation, and I had the unusual experience of learning Python by reading my own book.

Jeff and I revised the book, incorporated a case study by Chris Meyers, and in 2001 we released *How to Think Like a Computer Scientist: Learning with Python*, also under the

GNU Free Documentation License. As Green Tea Press, I published the book and started selling hard copies through Amazon.com and college book stores. Other books from Green Tea Press are available at greenteapress.com.

In 2003 I started teaching at Olin College and I got to teach Python for the first time. The contrast with Java was striking. Students struggled less, learned more, worked on more interesting projects, and generally had a lot more fun.

Over the last five years I have continued to develop the book, correcting errors, improving some of the examples and adding material, especially exercises. In 2008 I started work on a major revision—at the same time, I was contacted by an editor at Cambridge University Press who was interested in publishing the next edition. Good timing!

I hope you enjoy working with this book, and that it helps you learn to program and think, at least a little bit, like a computer scientist.

Acknowledgements for “Think Python”

(Allen B. Downey)

First and most importantly, I thank Jeff Elkner, who translated my Java book into Python, which got this project started and introduced me to what has turned out to be my favorite language.

I also thank Chris Meyers, who contributed several sections to *How to Think Like a Computer Scientist*.

And I thank the Free Software Foundation for developing the GNU Free Documentation License, which helped make my collaboration with Jeff and Chris possible.

I also thank the editors at Lulu who worked on *How to Think Like a Computer Scientist*.

I thank all the students who worked with earlier versions of this book and all the contributors (listed in an Appendix) who sent in corrections and suggestions.

And I thank my wife, Lisa, for her work on this book, and Green Tea Press, and everything else, too.

Allen B. Downey
Needham MA

Allen Downey is an Associate Professor of Computer Science at the Franklin W. Olin College of Engineering.

Contents

Preface	v
1 Why should you learn to write programs?	1
1.1 Creativity and motivation	2
1.2 Computer hardware architecture	3
1.3 Understanding programming	4
1.4 The Python programming language	5
1.5 What is a program?	6
1.6 What is debugging?	7
1.7 Building “sentences” in Python	9
1.8 The first program	11
1.9 Debugging	11
1.10 Glossary	12
1.11 Exercises	13
2 Variables, expressions and statements	15
2.1 Values and types	15
2.2 Variables	16
2.3 Variable names and keywords	17
2.4 Statements	18
2.5 Operators and operands	18
2.6 Expressions	19

2.7	Order of operations	20
2.8	Modulus operator	20
2.9	String operations	21
2.10	Asking the user for input	21
2.11	Comments	22
2.12	Choosing mnemonic variable names	23
2.13	Debugging	24
2.14	Glossary	25
2.15	Exercises	26
3	Conditional execution	29
3.1	Boolean expressions	29
3.2	Logical operators	30
3.3	Conditional execution	30
3.4	Alternative execution	31
3.5	Chained conditionals	31
3.6	Nested conditionals	32
3.7	Catching exceptions using try and except	32
3.8	Short circuit evaluation of logical expressions	34
3.9	Debugging	35
3.10	Glossary	36
3.11	Exercises	37
4	Functions	39
4.1	Function calls	39
4.2	Built-in functions	39
4.3	Type conversion functions	40
4.4	Random numbers	41
4.5	Optional parameters	41
4.6	Glossary	42

Contents	xi
4.7 Math functions	42
4.8 Adding new functions	43
4.9 Definitions and uses	45
4.10 Flow of execution	45
4.11 Parameters and arguments	46
4.12 Fruitful functions and void functions	47
4.13 Why functions?	48
4.14 Debugging	49
4.15 Glossary	49
4.16 Exercises	50
5 Iteration	51
5.1 Updating variables	51
5.2 The while statement	51
5.3 Infinite loops	52
5.4 “Infinite loops” and break	53
5.5 Finishing iterations with continue	55
5.6 Definite loops using for	55
5.7 Loop patterns	56
5.8 Debugging	59
5.9 Glossary	59
5.10 Exercises	60
6 Strings	61
6.1 A string is a sequence	61
6.2 Getting the length of a string using len	62
6.3 Traversal through a string with a for loop	62
6.4 String slices	63
6.5 Strings are immutable	64
6.6 Searching	65

6.7	Looping and counting	65
6.8	The <code>in</code> operator	66
6.9	String comparison	66
6.10	<code>string</code> methods	66
6.11	Parsing strings	69
6.12	Format operator	69
6.13	Debugging	70
6.14	Glossary	73
6.15	Exercises	74
7	Files	77
7.1	Persistence	77
7.2	Opening files	78
7.3	Text files and lines	78
7.4	Reading files	80
7.5	Searching through a file	81
7.6	Letting the user choose the file name	83
7.7	Using <code>try</code> , <code>catch</code> , and <code>open</code>	83
7.8	Writing files	85
7.9	Debugging	86
7.10	Glossary	86
7.11	Exercises	86
8	Lists	89
8.1	A list is a sequence	89
8.2	Lists are mutable	90
8.3	Traversing a list	91
8.4	List operations	91
8.5	List slices	92
8.6	List methods	92

8.7	Deleting elements	93
8.8	Lists and strings	94
8.9	Parsing lines	95
8.10	Objects and values	96
8.11	Aliasing	97
8.12	List arguments	97
8.13	Debugging	99
8.14	Glossary	102
8.15	Exercises	103
9	Dictionaries	105
9.1	Dictionary as a set of counters	107
9.2	Dictionaries and files	108
9.3	Looping and dictionaries	109
9.4	Advanced text parsing	110
9.5	Debugging	112
9.6	Glossary	113
9.7	Exercises	113
10	Tuples	115
10.1	Tuples are immutable	115
10.2	Comparing tuples	116
10.3	Tuple assignment	117
10.4	Dictionaries and tuples	119
10.5	Multiple assignment with dictionaries	119
10.6	The most common words	120
10.7	Using tuples as keys in dictionaries	121
10.8	Sequences: strings, lists, and tuples—Oh My!	122
10.9	Debugging	123
10.10	Glossary	124
10.11	Exercises	125

11 Automating common tasks on your computer	127
11.1 File names and paths	127
11.2 Example: Cleaning up a photo directory	128
11.3 Command line arguments	133
11.4 Pipes	135
11.5 Glossary	135
11.6 Exercises	136
12 Networked programs	139
12.1 HyperText Transport Protocol - HTTP	139
12.2 The World's Simplest Web Browser	140
12.3 Retrieving web pages with urllib	141
12.4 Parsing HTML and scraping the web	142
12.5 Glossary	144
12.6 Exercises	145
13 Using Web Services	147
13.1 eXtensible Markup Language - XML	147
13.2 Parsing XML	147
13.3 Looping through nodes	148
13.4 Application Programming Interfaces (API)	149
13.5 Twitter web services	150
13.6 Handling XML data from an API	152
13.7 Glossary	153
13.8 Exercises	154
14 Using databases and Structured Query Language (SQL)	155
14.1 What is a database?	155
14.2 Database concepts	155
14.3 SQLite Database Browser	156

14.4	Creating a database table	156
14.5	Structured Query Language (SQL) summary	159
14.6	Spidering Twitter using a database	160
14.7	Basic data modeling	165
14.8	Programming with multiple tables	166
14.9	Three kinds of keys	171
14.10	Using JOIN to retrieve data	172
14.11	Summary	174
14.12	Debugging	174
14.13	Glossary	175
15	Advanced functions	177
15.1	Return values	177
15.2	Tuples as return values	178
15.3	Variable-length argument tuples	179
15.4	Variables and parameters are local	180
15.5	Global variables	180
15.6	Incremental development	182
15.7	Composition	184
15.8	Stack diagrams	185
15.9	Boolean functions	186
15.10	Optional parameters	186
15.11	Debugging	187
15.12	Glossary	188
15.13	Exercises	189
A	Debugging	191
A.1	Syntax errors	191
A.2	Runtime errors	193
A.3	Semantic errors	196
B	Contributor List	199

Chapter 1

Why should you learn to write programs?

Writing programs (or programming) is a very creative and rewarding activity. You can write programs for many reasons ranging from making your living to solving a difficult data analysis problem to having fun to helping someone else solve a problem. This book assumes that *everyone* needs to know how to program and that once you know how to program, you will figure out what you want to do with your newfound skills.

We are surrounded in our daily lives with computers ranging from laptops to cell phones. We can think of these computers as our “personal assistants” who can take care of many things on our behalf. The hardware in our current-day computers is essentially built to continuously ask us the question, “What would you like me to do next?”.

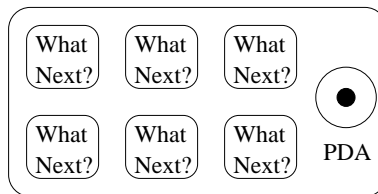

Programmers add an operating system and a set of applications to the hardware and we end up with a Personal Digital Assistant that is quite helpful and capable of helping many different things.

Our computers are fast and have vast amounts of memory and could be very helpful to us if we only knew the language to speak to explain to the computer what we would like it to “do next”. If we knew this language we could tell the computer to do tasks on our behalf that were repetitive. Interestingly, the kinds of things computers can do best are often the kinds of things that we humans find boring and mind-numbing.

For example, look at the first three paragraphs of this chapter and tell me the most commonly used word and how many times the word is used. While you were able to read and

understand the words in a few seconds, counting them is almost painful because it is not the kind of problem that human minds are designed to solve. For a computer the opposite is true, reading and understanding text from a piece of paper is hard for a computer to do but counting the words and telling you how many times the most used word was used is very easy for the computer:

```
python words.py
Enter file:words.txt
to 16
```

Our “personal information analysis assistant” quickly told us that the word “to” was used sixteen times in the first three paragraphs of this chapter.

This very fact that computers are good at things that humans are not is why you need to become skilled at talking “computer language”. Once you learn this new language, you can delegate mundane tasks to your partner (the computer), leaving more time for you to do the things that you are uniquely suited for. You bring creativity, intuition, and inventiveness to this partnership.

1.1 Creativity and motivation

While this book is not intended for professional programmers, professional programming can be a very rewarding job both financially and personally. Building useful, elegant, and clever programs for others to use is a very creative activity. Your computer or Personal Digital Assistant (PDA) usually contains many different programs from many different groups of programmers, each competing for your attention and interest. They try their best to meet your needs and give you a great user experience in the process. In some situations, when you choose a piece of software, the programmers are directly compensated because of your choice.

If we think of programs as the creative output of groups of programmers, perhaps the following figure is a more sensible version of our PDA:

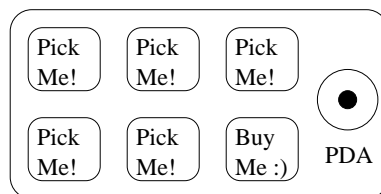

For now, our primary motivation is not to make money or please end-users, but instead for us to be more productive in handling the data and information that we will encounter in our lives. When you first start, you will be both the programmer and end-user of your programs. As you gain skill as a programmer and programming feels more creative to you, your thoughts may turn toward developing programs for others.

1.2 Computer hardware architecture

Before we start learning the language we speak to give instructions to computers to develop software, we need to learn a small amount about how computers are built. If you were to take apart your computer or cell phone and look deep inside, you would find the following parts:

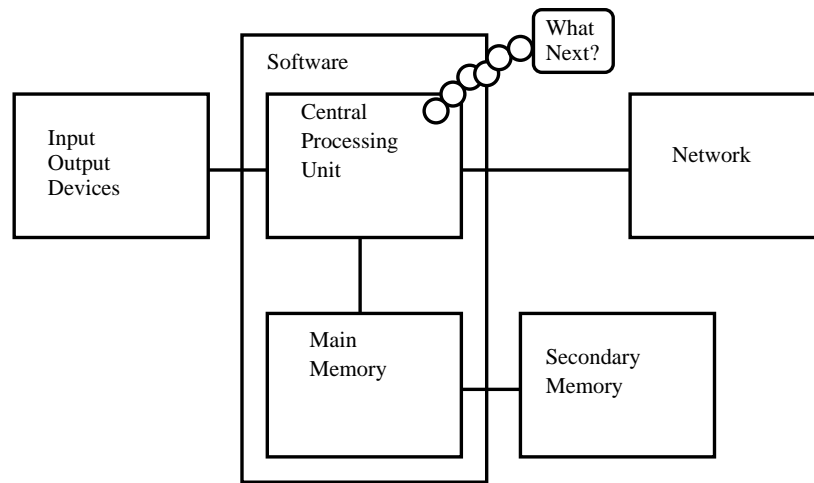

The high-level definitions of these parts are as follows:

- The **Central Processing Unit** (or CPU) is that part of the computer that is built to be obsessed with “what is next?”. If your computer is rated at 3.0 Gigahertz, it means that the CPU will ask “What next?” three billion times per second. You are going to have to learn how to talk fast to keep up with the CPU.
- The **Main Memory** is used to store information that the CPU needs in a hurry. The main memory is nearly as fast as the CPU. But the information stored in the main memory vanishes when the computer is turned off.
- The **Secondary Memory** is also used to store information, but it is much slower than the main memory. The advantage of the secondary memory is that it can store information even when there is no power to the computer. Examples of secondary memory are disk drives or flash memory (typically found in USB sticks and portable music players).
- The **Input and Output Devices** are simply our screen, keyboard, mouse, microphone, speaker, touchpad, etc. They are all of the ways we interact with the computer.
- These days, most computers also have a **Network Connection** to retrieve information over a network. We can think of the network as a very slow place to store and retrieve data that might not always be “up”. So in a sense, the network is a slower and at times unreliable form of **Secondary Memory**

While most of the detail of how these components work is best left to computer builders, it helps to have a some terminology so we can talk about these different parts as we write our programs.

As a programmer, your job is to use and orchestrate each of these resources to solve the problem that you need solving and analyze the data you need. As a programmer you will mostly be “talking” to the CPU and telling it what to do next. Sometimes you will tell the CPU to use the main memory, secondary memory, network, or the input/output devices.

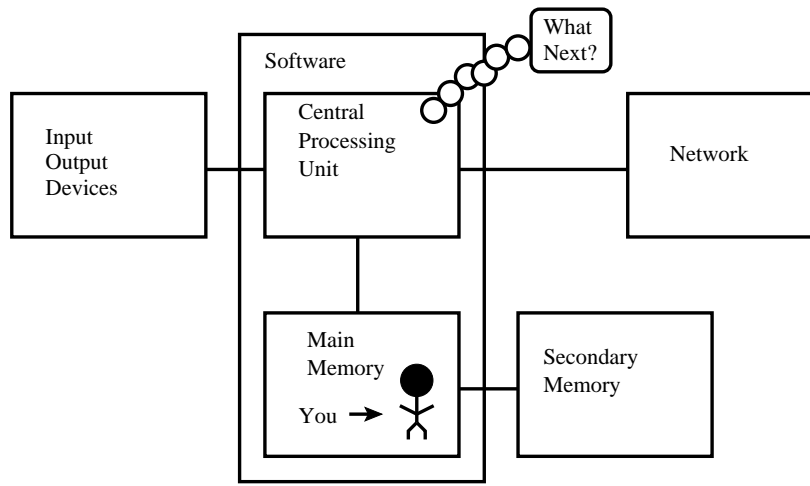

You need to be the person who answers the CPU’s “What next?” question. But it would be very uncomfortable to shrink you down to 5mm tall and insert you into the computer just so you could issue a command three billion times per second. So instead, you must write down your instructions in advance. We call these stored instructions a **program** and the act of writing these instructions down and getting the instructions to be correct **programming**.

1.3 Understanding programming

In the rest of this book, we will try to turn you into a person who is skilled in the art of programming. In the end you will be a **programmer** — perhaps not a professional programmer but at least you will have the skills to look at a data/information analysis problem and develop a program to solve the problem.

In a sense, you need two skills to be a programmer:

- First you need to know the programming language (Python) - you need to know the vocabulary and the grammar. You need to be able spell the words in this new language properly and how to construct well-formed “sentences” in this new languages.
- Second you need to “tell a story”. In writing a story, you combine words and sentences to convey an idea to the reader. There is a skill and art in constructing the story

and skill in story writing is improved by doing some writing and getting some feedback. In programming, our program is the “story” and the problem you are trying to solve is the “idea”.

Once you learn one programming language such as Python, you will find it much easier to learn a second programming language such as JavaScript or C++. The new programming language has very different vocabulary and grammar but once you learn problem solving skills, they will be the same across all programming languages.

You will learn the “vocabulary” and “sentences” of Python pretty quickly. It will take longer for you to be able to write a coherent program to solve a brand new problem. We teach programming much like we teach writing. We start reading and explaining programs and then we write simple programs and then write increasingly complex programs over time. At some point you “get your muse” and see the patterns on your own and can see more naturally how to take a problem and write a program that solves that problem. And once you get to that point, programming becomes a very pleasant and creative process.

We start with the vocabulary and structure of Python programs. Be patient as the simple examples remind you of when you started reading for the first time.

1.4 The Python programming language

The programming language you will learn is Python. Python is an example of a **high-level language**; other high-level languages you might have heard of are C, C++, Perl, Java, Ruby, and JavaScript. At times, we will include a few examples of the JavaScript language to help cement the basic grammar ideas using two different “vocabularies”.

There are also **low-level languages**, sometimes referred to as “machine languages” or “assembly languages.” Loosely speaking, computers can only execute programs written in low-level languages. So programs written in a high-level language have to be processed before they can run. This extra processing takes some time, which is a small disadvantage of high-level languages.

However, the advantages are enormous. First, it is much easier to program in a high-level language. Programs written in a high-level language take less time to write, they are shorter and easier to read, and they are more likely to be correct. Second, high-level languages are **portable**, meaning that they can run on different kinds of computers with few or no modifications. Low-level programs can run on only one kind of computer and have to be rewritten to run on another.

Due to these advantages, almost all programs are written in high-level languages. Low-level languages are used only for a few specialized applications.

Two kinds of programs process high-level languages into low-level languages: **interpreters** and **compilers**. An interpreter reads a high-level program and executes it, meaning that it does what the program says. It processes the program a little at a time, alternately reading lines and performing computations.



A compiler reads the program and translates it completely before the program starts running. In this context, the high-level program is called the **source code**, and the translated program is called the **object code**, **machine code** or the **executable**. Once a program is compiled, you can execute it repeatedly without further translation.

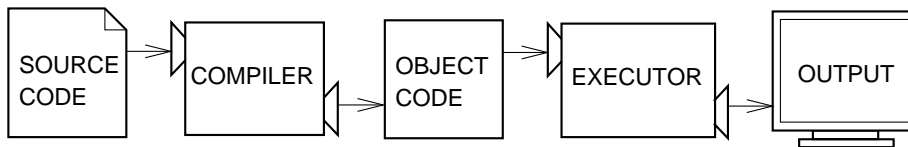

Python is considered an interpreted language because Python programs are executed by an interpreter. There are two ways to use the interpreter: **interactive mode** and **script mode**. In interactive mode, you type Python programs and the interpreter prints the result:

```

>>> 1 + 1
2
>>>
  
```

The chevron, `>>>`, is the **prompt** the interpreter uses to indicate that it is ready. If you type `1 + 1`, the interpreter replies `2`. The chevron is the Python interpreter's way of asking you, "What do you want me to do next?". You will notice that as soon as Python finishes one statement it immediately is ready for you to type another statement.

Typing commands into the Python interpreter is a great way to experiment with Python's features, but it is a bad way to type in many commands to solve a more complex problem. When we want to write a program, we use a text editor to write the Python instructions into a file, which is called a **script**. By convention, Python scripts have names that end with `.py`.

To execute the script, you have to tell the interpreter the name of the file. In a UNIX or Windows command window, you would type `python dinsdale.py`. In other development environments, the details of executing scripts are different. You can find instructions for your environment at the Python Website python.org.

Working in interactive mode is convenient for testing small pieces of code because you can type and execute them immediately. But for anything more than a few lines, you should save your code as a script so you can modify and execute it in the future.

1.5 What is a program?

A **program** is a sequence of instructions that specifies how to perform a computation. The computation might be something mathematical, such as solving a system of equations

or finding the roots of a polynomial, but it can also be a symbolic computation, such as searching and replacing text in a document or (strangely enough) compiling a program.

The details look different in different languages, but a few basic instructions appear in just about every language:

input: Get data from the keyboard, a file, or some other device, pausing if necessary.

output: Display data on the screen or send data to a file or other device.

sequential execution: Perform statements one after another in the order they are encountered in the script.

conditional execution: Check for certain conditions and execute or skip a sequence of statements.

repeated execution: Perform some set of statements repeatedly, usually with some variation.

reuse: Write a set of instructions once and give them a name and then reuse those instructions as needed throughout your program.,

Believe it or not, that's pretty much all there is to it. Every program you've ever used, no matter how complicated, is made up of instructions that look pretty much like these. So you can think of programming as the process of breaking a large, complex task into smaller and smaller subtasks until the subtasks are simple enough to be performed with one of these basic instructions.

That may be a little vague, but we will come back to this topic when we talk about **algorithms**.

1.6 What is debugging?

Programming is error-prone. For whimsical reasons, programming errors are called **bugs** and the process of tracking them down is called **debugging**.

Three kinds of errors can occur in a program: syntax errors, runtime errors, and semantic errors. It is useful to distinguish between them in order to track them down more quickly.

1.6.1 Syntax errors

Python can only execute a program if the syntax is correct; otherwise, the interpreter displays an error message. **Syntax** refers to the structure of a program and the rules about that structure. For example, parentheses have to come in matching pairs, so $(1 + 2)$ is legal, but $8)$ is a **syntax error**.

In English readers can tolerate most syntax errors, which is why we can read certain abstract poetry. Python is not so forgiving. If there is a single syntax error anywhere in your

program, Python will display an error message and quit, and you will not be able to run your program. During the first few weeks of your programming career, you will probably spend a lot of time tracking down syntax errors. As you gain experience, you will make fewer errors and find them faster.

1.6.2 Runtime errors

The second type of error is a runtime error, so called because the error does not appear until after the program has started running. These errors are also called **exceptions** because they usually indicate that something exceptional (and bad) has happened.

Runtime errors are rare in the simple programs you will see in the first few chapters, so it might be a while before you encounter one.

1.6.3 Semantic errors

The third type of error is the **semantic error**. If there is a semantic error in your program, it will run successfully in the sense that the computer will not generate any error messages, but it will not do the right thing. It will do something else. Specifically, it will do what you told it to do but not what you meant for it to do.

The problem is that the program you wrote is not the program you wanted to write. The meaning of the program (its semantics) is wrong. Identifying semantic errors can be tricky because it requires you to work backward by looking at the output of the program and trying to figure out what it is doing.

1.6.4 Experimental debugging

One of the most important skills you will acquire is debugging. Although it can be frustrating, debugging is one of the most intellectually rich, challenging, and interesting parts of programming.

In some ways, debugging is like detective work. You are confronted with clues, and you have to infer the processes and events that led to the results you see.

Debugging is also like an experimental science. Once you have an idea about what is going wrong, you modify your program and try again. If your hypothesis was correct, then you can predict the result of the modification, and you take a step closer to a working program. If your hypothesis was wrong, you have to come up with a new one. As Sherlock Holmes pointed out, “When you have eliminated the impossible, whatever remains, however improbable, must be the truth.” (A. Conan Doyle, *The Sign of Four*)

For some people, programming and debugging are the same thing. That is, programming is the process of gradually debugging a program until it does what you want. The idea is that you should start with a program that does *something* and make small modifications, debugging them as you go, so that you always have a working program.

For example, Linux is an operating system that contains thousands of lines of code, but it started out as a simple program Linus Torvalds used to explore the Intel 80386 chip. According to Larry Greenfield, “One of Linus’s earlier projects was a program that would switch between printing AAAA and BBBB. This later evolved to Linux.” (*The Linux Users’ Guide Beta Version 1*).

Later chapters will make more suggestions about debugging and other programming practices.

1.7 Building “sentences” in Python

The rules (or grammar) of Python are simpler and more precise than the rules of a natural language that we use to speak and write.

Natural languages are the languages people speak, such as English, Spanish, and French. They were not designed by people (although people try to impose some order on them); they evolved naturally.

Formal languages are languages that are designed by people for specific applications. For example, the notation that mathematicians use is a formal language that is particularly good at denoting relationships among numbers and symbols. Chemists use a formal language to represent the chemical structure of molecules. And most importantly:

Programming languages are formal languages that have been designed to express computations.

Formal languages tend to have strict rules about syntax. For example, $3 + 3 = 6$ is a syntactically correct mathematical statement, but $3 + = 3\$6$ is not. H_2O is a syntactically correct chemical formula, but $_2Zz$ is not.

Syntax rules come in two flavors, pertaining to **tokens** and structure. Tokens are the basic elements of the language, such as words, numbers, and chemical elements. One of the problems with $3 + = 3\$6$ is that $\$$ is not a legal token in mathematics (at least as far as I know). Similarly, $_2Zz$ is not legal because there is no element with the abbreviation Zz .

The second type of syntax error pertains to the structure of a statement; that is, the way the tokens are arranged. The statement $3 + = 3\$6$ is illegal because even though $+$ and $=$ are legal tokens, you can’t have one right after the other. Similarly, in a chemical formula the subscript comes after the element name, not before.

Exercise 1.1 Write a well-structured English sentence with invalid tokens in it. Then write another sentence with all valid tokens but with invalid structure.

When you read a sentence in English or a statement in a formal language, you have to figure out what the structure of the sentence is (although in a natural language you do this subconsciously). This process is called **parsing**.

For example, when you hear the sentence, “The penny dropped,” you understand that “the penny” is the subject and “dropped” is the predicate. Once you have parsed a sentence, you can figure out what it means, or the semantics of the sentence. Assuming that you know what a penny is and what it means to drop, you will understand the general implication of this sentence.

Although formal and natural languages have many features in common—tokens, structure, syntax, and semantics—there are some differences:

ambiguity: Natural languages are full of ambiguity, which people deal with by using contextual clues and other information. Formal languages are designed to be nearly or completely unambiguous, which means that any statement has exactly one meaning, regardless of context.

redundancy: In order to make up for ambiguity and reduce misunderstandings, natural languages employ lots of redundancy. As a result, they are often verbose. Formal languages are less redundant and more concise.

literalness: Natural languages are full of idiom and metaphor. If I say, “The penny dropped,” there is probably no penny and nothing dropping¹. Formal languages mean exactly what they say.

People who grow up speaking a natural language—everyone—often have a hard time adjusting to formal languages. In some ways, the difference between formal and natural language is like the difference between poetry and prose, but more so:

Poetry: Words are used for their sounds as well as for their meaning, and the whole poem together creates an effect or emotional response. Ambiguity is not only common but often deliberate.

Prose: The literal meaning of words is more important, and the structure contributes more meaning. Prose is more amenable to analysis than poetry but still often ambiguous.

Programs: The meaning of a computer program is unambiguous and literal, and can be understood entirely by analysis of the tokens and structure.

Here are some suggestions for reading programs (and other formal languages). First, remember that formal languages are much more dense than natural languages, so it takes longer to read them. Also, the structure is very important, so it is usually not a good idea to read from top to bottom, left to right. Instead, learn to parse the program in your head, identifying the tokens and interpreting the structure. Finally, the details matter. Small errors in spelling and punctuation, which you can get away with in natural languages, can make a big difference in a formal language.

¹This idiom means that someone realized something after a period of confusion.

1.8 The first program

Traditionally, the first program you write in a new language is called “Hello, World!” because all it does is display the words, “Hello, World!” In Python, it looks like this:

```
print 'Hello, World!'
```

This is an example of a **print statement**², which doesn’t actually print anything on paper. It displays a value on the screen. In this case, the result is the words

```
Hello, World!
```

The quotation marks in the program mark the beginning and end of the text to be displayed; they don’t appear in the result.

Some people judge the quality of a programming language by the simplicity of the “Hello, World!” program. By this standard, Python does about as well as possible.

1.9 Debugging

It is a good idea to read this book in front of a computer so you can try out the examples as you go. You can run most of the examples in interactive mode, but if you put the code into a script, it is easier to try out variations.

Whenever you are experimenting with a new feature, you should try to make mistakes. For example, in the “Hello, world!” program, what happens if you leave out one of the quotation marks? What if you leave out both? What if you spell `print` wrong?

This kind of experiment helps you remember what you read; it also helps with debugging, because you get to know what the error messages mean. It is better to make mistakes now and on purpose than later and accidentally.

Programming, and especially debugging, sometimes brings out strong emotions. If you are struggling with a difficult bug, you might feel angry, despondent or embarrassed.

There is evidence that people naturally respond to computers as if they were people³. When they work well, we think of them as teammates, and when they are obstinate or rude, we respond to them the same way we respond to rude, obstinate people.

Preparing for these reactions might help you deal with them. One approach is to think of the computer as an employee with certain strengths, like speed and precision, and particular weaknesses, like lack of empathy and inability to grasp the big picture.

Your job is to be a good manager: find ways to take advantage of the strengths and mitigate the weaknesses. And find ways to use your emotions to engage with the problem, without letting your reactions interfere with your ability to work effectively.

²In Python 3.0, `print` is a function, not a statement, so the syntax is `print('Hello, World!')`. We will get to functions soon!

³See Reeves and Nass, *The Media Equation: How People Treat Computers, Television, and New Media Like Real People and Places*.

Learning to debug can be frustrating, but it is a valuable skill that is useful for many activities beyond programming. At the end of each chapter there is a debugging section, like this one, with my thoughts about debugging. I hope they help!

1.10 Glossary

central processing unit: The heart of any computer. It is what runs the software that we write; also called “CPU” or “the processor”.

main memory: Stores programs and data. Main memory loses its information when the power is turned off.

secondary memory: Stores programs and data and retains its information even when the power is turned off. Generally slower than main memory. Examples of secondary memory include disk drives and flash member in USB sticks.

problem solving: The process of formulating a problem, finding a solution, and expressing the solution.

high-level language: A programming language like Python that is designed to be easy for humans to read and write.

low-level language: A programming language that is designed to be easy for a computer to execute; also called “machine code” or “assembly language.”

machine code: The lowest level language for software which is the language that is directly executed by the central processing unit (CPU).

portability: A property of a program that can run on more than one kind of computer.

interpret: To execute a program in a high-level language by translating it one line at a time.

compile: To translate a program written in a high-level language into a low-level language all at once, in preparation for later execution.

source code: A program in a high-level language before being compiled.

object code: The output of the compiler after it translates the program.

executable: Another name for object code that is ready to be executed.

prompt: Characters displayed by the interpreter to indicate that it is ready to take input from the user.

script: A program stored in a file (usually one that will be interpreted).

interactive mode: A way of using the Python interpreter by typing commands and expressions at the prompt.

script mode: A way of using the Python interpreter to read and execute statements in a script.

program: A set of instructions that specifies a computation.

algorithm: A general process for solving a category of problems.

bug: An error in a program.

debugging: The process of finding and removing any of the three kinds of programming errors.

syntax: The structure of a program.

syntax error: An error in a program that makes it impossible to parse (and therefore impossible to interpret).

exception: An error that is detected while the program is running.

semantics: The meaning of a program.

semantic error: An error in a program that makes it do something other than what the programmer intended.

natural language: Any one of the languages that people speak that evolved naturally.

formal language: Any one of the languages that people have designed for specific purposes, such as representing mathematical ideas or computer programs; all programming languages are formal languages.

token: One of the basic elements of the syntactic structure of a program, analogous to a word in a natural language.

parse: To examine a program and analyze the syntactic structure.

print statement: An instruction that causes the Python interpreter to display a value on the screen.

1.11 Exercises

Exercise 1.2 Use a web browser to go to the Python Website python.org. This page contains information about Python and links to Python-related pages, and it gives you the ability to search the Python documentation.

For example, if you enter `print` in the search window, the first link that appears is the documentation of the `print` statement. At this point, not all of it will make sense to you, but it is good to know where it is.

Exercise 1.3 Start the Python interpreter and type `help()` to start the online help utility. Or you can type `help('print')` to get information about the `print` statement.

If this example doesn't work, you may need to install additional Python documentation or set an environment variable; the details depend on your operating system and version of Python.

Exercise 1.4 Start the Python interpreter and use it as a calculator. Python's syntax for math operations is almost the same as standard mathematical notation. For example, the symbols +, - and / denote addition, subtraction and division, as you would expect. The symbol for multiplication is *.

If you run a 10 kilometer race in 43 minutes 30 seconds, what is your average time per mile? What is your average speed in miles per hour? (Hint: there are 1.61 kilometers in a mile).

Chapter 2

Variables, expressions and statements

2.1 Values and types

A **value** is one of the basic things a program works with, like a letter or a number. The values we have seen so far are 1, 2, and 'Hello, World!'.

These values belong to different **types**: 2 is an integer, and 'Hello, World!' is a **string**, so-called because it contains a “string” of letters. You (and the interpreter) can identify strings because they are enclosed in quotation marks.

The print statement also works for integers. We use the python command to start the interpreter.

```
python
>>> print 4
4
```

If you are not sure what type a value has, the interpreter can tell you.

```
>>> type('Hello, World!')
<type 'str'>
>>> type(17)
<type 'int'>
```

Not surprisingly, strings belong to the type `str` and integers belong to the type `int`. Less obviously, numbers with a decimal point belong to a type called `float`, because these numbers are represented in a format called **floating-point**.

```
>>> type(3.2)
<type 'float'>
```

What about values like '17' and '3.2'? They look like numbers, but they are in quotation marks like strings.

```
>>> type('17')
<type 'str'>
>>> type('3.2')
<type 'str'>
```

They're strings.

When you type a large integer, you might be tempted to use commas between groups of three digits, as in 1,000,000. This is not a legal integer in Python, but it is legal:

```
>>> print 1,000,000
1 0 0
```

Well, that's not what we expected at all! Python interprets 1,000,000 as a comma-separated sequence of integers, which it prints with spaces between.

This is the first example we have seen of a semantic error: the code runs without producing an error message, but it doesn't do the "right" thing.

2.2 Variables

One of the most powerful features of a programming language is the ability to manipulate **variables**. A variable is a name that refers to a value.

An **assignment statement** creates new variables and gives them values:

```
>>> message = 'And now for something completely different '
>>> n = 17
>>> pi = 3.1415926535897931
```

This example makes three assignments. The first assigns a string to a new variable named `message`; the second assigns the integer 17 to `n`; the third assigns the (approximate) value of π to `pi`.

A common way to represent variables on paper is to write the name with an arrow pointing to the variable's value. This kind of figure is called a **state diagram** because it shows what state each of the variables is in (think of it as the variable's state of mind). This diagram shows the result of the previous example:

message	—>	'And now for something completely different'
n	—>	17
pi	—>	3.1415926535897931

To display the value of a variable, you can use a print statement:

```
>>> print n
17
>>> print pi
3.14159265359
```

The type of a variable is the type of the value it refers to.

```
>>> type(message)
<type 'str'>
>>> type(n)
<type 'int'>
>>> type(pi)
<type 'float'>
```

2.3 Variable names and keywords

Programmers generally choose names for their variables that are meaningful—they document what the variable is used for.

Variable names can be arbitrarily long. They can contain both letters and numbers, but they have to begin with a letter. It is legal to use uppercase letters, but it is a good idea to begin variable names with a lowercase letter (you'll see why later).

The underscore character (`_`) can appear in a name. It is often used in names with multiple words, such as `my_name` or `airspeed_of_unladen_swallow`.

If you give a variable an illegal name, you get a syntax error:

```
>>> 76trombones = 'big parade'
SyntaxError: invalid syntax
>>> more@ = 1000000
SyntaxError: invalid syntax
>>> class = 'Advanced Theoretical Zymurgy'
SyntaxError: invalid syntax
```

`76trombones` is illegal because it does not begin with a letter. `more@` is illegal because it contains an illegal character, `@`. But what's wrong with `class`?

It turns out that `class` is one of Python's **keywords**. The interpreter uses keywords to recognize the structure of the program, and they cannot be used as variable names.

Python reserves 31 keywords¹ for its use:

<code>and</code>	<code>del</code>	<code>from</code>	<code>not</code>	<code>while</code>
<code>as</code>	<code>elif</code>	<code>global</code>	<code>or</code>	<code>with</code>
<code>assert</code>	<code>else</code>	<code>if</code>	<code>pass</code>	<code>yield</code>
<code>break</code>	<code>except</code>	<code>import</code>	<code>print</code>	

¹In Python 3.0, `exec` is no longer a keyword, but `nonlocal` is.

```
class    exec    in    raise
continue finally is    return
def      for    lambda try
```

You might want to keep this list handy. If the interpreter complains about one of your variable names and you don't know why, see if it is on this list.

2.4 Statements

A **statement** is a unit of code that the Python interpreter can execute. We have seen two kinds of statements: print and assignment.

When you type a statement in interactive mode, the interpreter executes it and displays the result, if there is one.

A script usually contains a sequence of statements. If there is more than one statement, the results appear one at a time as the statements execute.

For example, the script

```
print 1
x = 2
print x
```

produces the output

```
1
2
```

The assignment statement produces no output.

2.5 Operators and operands

Operators are special symbols that represent computations like addition and multiplication. The values the operator is applied to are called **operands**.

The operators +, -, *, / and ** perform addition, subtraction, multiplication, division and exponentiation, as in the following examples:

```
20+32    hour-1    hour*60+minute    minute/60    5**2    (5+9)*(15-7)
```

In some other languages, ^ is used for exponentiation, but in Python it is a bitwise operator called XOR. I won't cover bitwise operators in this book, but you can read about them at wiki.python.org/moin/BitwiseOperators.

The division operator might not do what you expect:

```
>>> minute = 59
>>> minute/60
0
```

The value of `minute` is 59, and in conventional arithmetic 59 divided by 60 is 0.98333, not 0. The reason for the discrepancy is that Python is performing **floor division**².

When both of the operands are integers, the result is also an integer; floor division chops off the fraction part, so in this example it rounds down to zero.

If either of the operands is a floating-point number, Python performs floating-point division, and the result is a `float`:

```
>>> minute/60.0
0.98333333333333328
```

2.6 Expressions

An **expression** is a combination of values, variables, and operators. A value all by itself is considered an expression, and so is a variable, so the following are all legal expressions (assuming that the variable `x` has been assigned a value):

```
17
x
x + 17
```

If you type an expression in interactive mode, the interpreter **evaluates** it and displays the result:

```
>>> 1 + 1
2
```

But in a script, an expression all by itself doesn't do anything! This is a common source of confusion for beginners.

Exercise 2.1 Type the following statements in the Python interpreter to see what they do:

```
5
x = 5
x + 1
```

Now we can use a text editor to place the same statements into a file (i.e. make a script) and run it. What is the output? Modify the script by transforming each *expression* into a print statement and then run it again.

²In Python 3.0, the result of this division is a `float`. The new operator `//` performs integer division.

2.7 Order of operations

When more than one operator appears in an expression, the order of evaluation depends on the **rules of precedence**. For mathematical operators, Python follows mathematical convention. The acronym **PEMDAS** is a useful way to remember the rules:

- **P**arentheses have the highest precedence and can be used to force an expression to evaluate in the order you want. Since expressions in parentheses are evaluated first, $2 * (3-1)$ is 4, and $(1+1)**(5-2)$ is 8. You can also use parentheses to make an expression easier to read, as in `(minute * 100) / 60`, even if it doesn't change the result.
- **E**xponentiation has the next highest precedence, so $2**1+1$ is 3, not 4, and $3*1**3$ is 3, not 27.
- **M**ultiplication and **D**ivision have the same precedence, which is higher than **A**ddition and **S**ubtraction, which also have the same precedence. So $2*3-1$ is 5, not 4, and $6+4/2$ is 8, not 5.
- Operators with the same precedence are evaluated from left to right. So in the expression `degrees / 2 * pi`, the division happens first and the result is multiplied by `pi`. To divide by 2π , you can reorder the operands or use parentheses.

2.8 Modulus operator

The **modulus operator** works on integers and yields the remainder when the first operand is divided by the second. In Python, the modulus operator is a percent sign (%). The syntax is the same as for other operators:

```
>>> quotient = 7 / 3
>>> print quotient
2
>>> remainder = 7 % 3
>>> print remainder
1
```

So 7 divided by 3 is 2 with 1 left over.

The modulus operator turns out to be surprisingly useful. For example, you can check whether one number is divisible by another—if `x % y` is zero, then `x` is divisible by `y`.

Also, you can extract the right-most digit or digits from a number. For example, `x % 10` yields the right-most digit of `x` (in base 10). Similarly `x % 100` yields the last two digits.

2.9 String operations

The `+` operator works with strings, but it is not addition in the mathematical sense. Instead it performs **concatenation**, which means joining the strings by linking them end-to-end. For example:

```
first = 'throat'
second = 'warbler'
print first + second
```

The output of this program is `throatwarbler`.

The `*` operator also works on strings; it performs repetition. For example, `'Spam'*3` is `'SpamSpamSpam'`. If one of the operands is a string, the other has to be an integer.

This use of `+` and `*` makes sense by analogy with addition and multiplication. Just as $4*3$ is equivalent to $4+4+4$, we expect `'Spam'*3` to be the same as `'Spam'+'Spam'+'Spam'`, and it is. On the other hand, there is a significant way in which string concatenation and repetition are different from integer addition and multiplication. Can you think of a property that addition has that string concatenation does not?

2.10 Asking the user for input

Sometimes we would like to take the value for a variable from the user via their keyboard. Python provides a built-in function called `raw_input` that gets input from the keyboard³. When this function is called, the program stops and waits for the user to type something. When the user presses Return or Enter, the program resumes and `raw_input` returns what the user typed as a string.

```
>>> input = raw_input()
Some silly stuff
>>> print input
Some silly stuff
```

Before getting input from the user, it is a good idea to print a prompt telling the user what to input. `raw_input` can take a prompt as an argument:

```
>>> name = raw_input('What...is your name?\n')
What...is your name?
Arthur, King of the Britons!
>>> print name
Arthur, King of the Britons!
```

The sequence `\n` at the end of the prompt represents a **newline**, which is a special character that causes a line break. That's why the user's input appears below the prompt.

If you expect the user to type an integer, you can try to convert the return value to `int` using the `int()` function:

³In Python 3.0, this function is named `input`.

```
>>> prompt = 'What...is the airspeed velocity of an unladen swallow?\n'
>>> speed = raw_input(prompt)
What...is the airspeed velocity of an unladen swallow?
17
>>> int(speed)
17
>>> int(speed) + 5
22
```

But if the user types something other than a string of digits, you get an error:

```
>>> speed = raw_input(prompt)
What...is the airspeed velocity of an unladen swallow?
What do you mean, an African or a European swallow?
>>> int(speed)
ValueError: invalid literal for int()
```

We will see how to handle this kind of error later.

2.11 Comments

As programs get bigger and more complicated, they get more difficult to read. Formal languages are dense, and it is often difficult to look at a piece of code and figure out what it is doing, or why.

For this reason, it is a good idea to add notes to your programs to explain in natural language what the program is doing. These notes are called **comments**, and they start with the # symbol:

```
# compute the percentage of the hour that has elapsed
percentage = (minute * 100) / 60
```

In this case, the comment appears on a line by itself. You can also put comments at the end of a line:

```
percentage = (minute * 100) / 60    # percentage of an hour
```

Everything from the # to the end of the line is ignored—it has no effect on the program.

Comments are most useful when they document non-obvious features of the code. It is reasonable to assume that the reader can figure out *what* the code does; it is much more useful to explain *why*.

This comment is redundant with the code and useless:

```
v = 5    # assign 5 to v
```

This comment contains useful information that is not in the code:

```
v = 5      # velocity in meters/second.
```

Good mnemonic variable names can reduce the need for comments, but long names can make complex expressions hard to read, so there is a tradeoff.

2.12 Choosing mnemonic variable names

As long as you follow the simple rules of variable naming, and avoid reserved words, you have a lot of choice when you name your variables. In the beginning, this choice can be confusing both when you read a program and when you write your own programs. For example, the following three programs are identical in terms of what they accomplish, but very different when you read them and try to understand them.

```
a = 35.0
b = 12.50
c = a * b
print c
```

```
hours = 35.0
rate = 12.50
pay = hours * rate
print pay
```

```
x1q3z9ahd = 35.0
x1q3z9afd = 12.50
x1q3p9afd = x1q3z9ahd * x1q3z9afd
print x1q3p9afd
```

The Python interpreter sees all three of these programs as *exactly the same* but humans see and understand these programs quite differently. Humans will most quickly understand the **intent** of the second program because the programmer has chosen variable names that reflect the intent of the programmer regarding what data will be stored in each variable.

We call these wisely-chosen variable names “mnemonic variable names”. The word *mnemonic*⁴ means “memory aid”. We choose mnemonic variable names to help us remember why we created the variable in the first place.

While this all sounds great, and it is a very good idea to use mnemonic variable names, mnemonic variable names can get in the way of a beginning programmer’s ability to parse and understand code. This is because beginning programmers have not yet memorized the reserved words (there are only 31 of them) and sometimes variables which have names that are too descriptive start to look like part of the language and not just well-chosen variable names.

Take a quick look at the following Python sample code which loops through some data. We will cover loops soon, but for now try to just puzzle through what this means:

⁴See <http://en.wikipedia.org/wiki/Mnemonic> for an extended description of the word “mnemonic”.

```
for word in words:  
    print word
```

What is happening here? Which of the tokens (for, word, in, etc.) are reserved words and which are just variable names? Does Python understand at a fundamental level the notion of words? Beginning programmers have trouble separating what parts of the code *must* be the same as this example and what parts of the code are simply choices made by the programmer.

The following code is equivalent to the above code:

```
for slice in pizza:  
    print slice
```

It is easier for the beginning programmer to look at this code and know which parts are reserved words defined by Python and which parts are simply variable names chosen by the programmer. It is pretty clear that Python has no fundamental understanding of pizza and slices and the fact that a pizza consists of a set of one or more slices.

But if our program is truly about reading data and looking for words in the data, `pizza` and `slice` are very un-mnemonic variable names choosing them as variable names distracts from the meaning of the program.

After a pretty short period of time, you will know the most common reserved words and you will start to see the reserved words jumping out at you:

```
for word in words:  
    print word
```

The parts of the code that are defined by Python (`for`, `in`, `print`, and `:`) are in bold and the programmer chosen variables (`word` and `words`) are not in bold. Many text editors are aware of Python syntax and will color reserved words differently to give you clues to keep your variables and reserved words separate. After a while you will begin to read Python and quickly determine what is a variable and what is a reserved word.

2.13 Debugging

At this point the syntax error you are most likely to make is an illegal variable name, like `class` and `yield`, which are keywords, or `odd~job` and `US$`, which contain illegal characters.

If you put a space in a variable name, Python thinks it is two operands without an operator:

```
>>> bad name = 5  
SyntaxError: invalid syntax
```

For syntax errors, the error messages don't help much. The most common messages are `SyntaxError: invalid syntax` and `SyntaxError: invalid token`, neither of which is very informative.

The runtime error you are most likely to make is a “use before def;” that is, trying to use a variable before you have assigned a value. This can happen if you spell a variable name wrong:

```
>>> principal = 327.68
>>> interest = principle * rate
NameError: name 'principle' is not defined
```

Variables names are case sensitive, so LaTeX is not the same as latex.

At this point the most likely cause of a semantic error is the order of operations. For example, to evaluate $\frac{1}{2\pi}$, you might be tempted to write

```
>>> 1.0 / 2.0 * pi
```

But the division happens first, so you would get $\pi/2$, which is not the same thing! There is no way for Python to know what you meant to write, so in this case you don’t get an error message; you just get the wrong answer.

2.14 Glossary

value: One of the basic units of data, like a number or string, that a program manipulates.

type: A category of values. The types we have seen so far are integers (type `int`), floating-point numbers (type `float`), and strings (type `str`).

integer: A type that represents whole numbers.

floating-point: A type that represents numbers with fractional parts.

string: A type that represents sequences of characters.

variable: A name that refers to a value.

mnemonic: A memory aid. We often give variables mnemonic names to help us remember what is stored in the variable.

statement: A section of code that represents a command or action. So far, the statements we have seen are assignments and print statements.

assignment: A statement that assigns a value to a variable.

state diagram: A graphical representation of a set of variables and the values they refer to.

keyword: A reserved word that is used by the compiler to parse a program; you cannot use keywords like `if`, `def`, and `while` as variable names.

operator: A special symbol that represents a simple computation like addition, multiplication, or string concatenation.

operand: One of the values on which an operator operates.

floor division: The operation that divides two numbers and chops off the fraction part.

modulus operator: An operator, denoted with a percent sign (%), that works on integers and yields the remainder when one number is divided by another.

expression: A combination of variables, operators, and values that represents a single result value.

evaluate: To simplify an expression by performing the operations in order to yield a single value.

rules of precedence: The set of rules governing the order in which expressions involving multiple operators and operands are evaluated.

concatenate: To join two operands end-to-end.

comment: Information in a program that is meant for other programmers (or anyone reading the source code) and has no effect on the execution of the program.

2.15 Exercises

Exercise 2.2 Write a program that uses `raw_input` to prompt a user for their name and then welcomes them.

```
Enter your name: Chuck
Hello Chuck
```

Exercise 2.3 Write a program to prompt the user for hours and rate per hour to compute gross pay.

```
Enter Hours: 35
Enter Rate: 2.75
Pay: 96.25
```

We won't worry about making sure our pay has exactly two digits after the decimal place for now. If you want, you can play with the built-in Python `round` function to properly round the resulting pay to two decimal places.

Exercise 2.4 Assume that we execute the following assignment statements:

```
width = 17
height = 12.0
```

For each of the following expressions, write the value of the expression and the type (of the value of the expression).

1. `width/2`
2. `width/2.0`

3. `height/3`

4. `1 + 2 * 5`

Use the Python interpreter to check your answers.

Exercise 2.5 Write a program which prompts the user for a Celsius temperature, convert the temperature to Fahrenheit and print out the converted temperature.

Chapter 3

Conditional execution

3.1 Boolean expressions

A **boolean expression** is an expression that is either true or false. The following examples use the operator `==`, which compares two operands and produces `True` if they are equal and `False` otherwise:

```
>>> 5 == 5
True
>>> 5 == 6
False
```

`True` and `False` are special values that belong to the type `bool`; they are not strings:

```
>>> type(True)
<type 'bool'>
>>> type(False)
<type 'bool'>
```

The `==` operator is one of the **comparison operators**; the others are:

<code>x != y</code>	<code># x is not equal to y</code>
<code>x > y</code>	<code># x is greater than y</code>
<code>x < y</code>	<code># x is less than y</code>
<code>x >= y</code>	<code># x is greater than or equal to y</code>
<code>x <= y</code>	<code># x is less than or equal to y</code>

Although these operations are probably familiar to you, the Python symbols are different from the mathematical symbols. A common error is to use a single equal sign (`=`) instead of a double equal sign (`==`). Remember that `=` is an assignment operator and `==` is a comparison operator. There is no such thing as `=<` or `=>`.

3.2 Logical operators

There are three **logical operators**: and, or, and not. The semantics (meaning) of these operators is similar to their meaning in English. For example, $x > 0$ and $x < 10$ is true only if x is greater than 0 *and* less than 10.

$n\%2 == 0$ or $n\%3 == 0$ is true if *either* of the conditions is true, that is, if the number is divisible by 2 *or* 3.

Finally, the not operator negates a boolean expression, so not $(x > y)$ is true if $x > y$ is false, that is, if x is less than or equal to y .

Strictly speaking, the operands of the logical operators should be boolean expressions, but Python is not very strict. Any nonzero number is interpreted as “true.”

```
>>> 17 and True
True
```

This flexibility can be useful, but there are some subtleties to it that might be confusing. You might want to avoid it (unless you know what you are doing).

3.3 Conditional execution

In order to write useful programs, we almost always need the ability to check conditions and change the behavior of the program accordingly. **Conditional statements** give us this ability. The simplest form is the if statement:

```
if x > 0 :
    print 'x is positive'
```

The boolean expression after the if statement is called the **condition**. We end the if statement with a colon character (:) and the line(s) after the if statement are indented. If the logical condition is true, then the indented statement gets executed. If the logical condition is false, the indented statement is skipped.

if statements have the same structure as function definitions or for loops. The statement consists of a header line that ends with the colon character (:) followed by an indented block. Statements like this are called **compound statements** because they stretch across more than one line.

There is no limit on the number of statements that can appear in the body, but there has to be at least one. Occasionally, it is useful to have a body with no statements (usually as a place keeper for code you haven't written yet). In that case, you can use the pass statement, which does nothing.

```
if x < 0 :
    pass          # need to handle negative values!
```

3.4 Alternative execution

A second form of the `if` statement is **alternative execution**, in which there are two possibilities and the condition determines which one gets executed. The syntax looks like this:

```
if x%2 == 0 :
    print 'x is even'
else :
    print 'x is odd'
```

If the remainder when `x` is divided by 2 is 0, then we know that `x` is even, and the program displays a message to that effect. If the condition is false, the second set of statements is executed. Since the condition must be true or false, exactly one of the alternatives will be executed. The alternatives are called **branches**, because they are branches in the flow of execution.

3.5 Chained conditionals

Sometimes there are more than two possibilities and we need more than two branches. One way to express a computation like that is a **chained conditional**:

```
if x < y:
    print 'x is less than y'
elif x > y:
    print 'x is greater than y'
else:
    print 'x and y are equal'
```

`elif` is an abbreviation of “else if.” Again, exactly one branch will be executed. There is no limit on the number of `elif` statements. If there is an `else` clause, it has to be at the end, but there doesn’t have to be one.

```
if choice == 'a':
    print 'Bad guess'
elif choice == 'b':
    print 'Good guess'
elif choice == 'c':
    print 'Close, but not correct'
```

Each condition is checked in order. If the first is false, the next is checked, and so on. If one of them is true, the corresponding branch executes, and the statement ends. Even if more than one condition is true, only the first true branch executes.

3.6 Nested conditionals

One conditional can also be nested within another. We could have written the trichotomy example like this:

```
if x == y:
    print 'x and y are equal'
else:
    if x < y:
        print 'x is less than y'
    else:
        print 'x is greater than y'
```

The outer conditional contains two branches. The first branch contains a simple statement. The second branch contains another if statement, which has two branches of its own. Those two branches are both simple statements, although they could have been conditional statements as well.

Although the indentation of the statements makes the structure apparent, **nested conditionals** become difficult to read very quickly. In general, it is a good idea to avoid them when you can.

Logical operators often provide a way to simplify nested conditional statements. For example, we can rewrite the following code using a single conditional:

```
if 0 < x:
    if x < 10:
        print 'x is a positive single-digit number.'
```

The print statement is executed only if we make it past both conditionals, so we can get the same effect with the and operator:

```
if 0 < x and x < 10:
    print 'x is a positive single-digit number.'
```

3.7 Catching exceptions using try and except

Earlier we saw a code segment where we used the `raw_input` and `int` functions to read and parse an integer number entered by the user. We also saw how treacherous doing this could be:

```
>>> speed = raw_input(prompt)
What...is the airspeed velocity of an unladen swallow?
What do you mean, an African or a European swallow?
>>> int(speed)
ValueError: invalid literal for int()
>>>
```

When we are executing these statements in the Python interpreter, we get a new prompt from the interpreter, think “oops” and move on to our next statement.

However if this code is placed in a Python script and this error occurs, your script immediately stops in its tracks with a traceback. It does not execute the following statement.

Here is a sample program to convert a Fahrenheit temperature to a Celsius temperature:

```
inp = raw_input('Enter Fahrenheit Temperature:')
fahr = float(inp)
cel = (fahr - 32.0) * 5.0 / 9.0
print cel
```

If we execute this code and give it invalid input, it simply fails with an unfriendly error message:

```
python fahren.py
Enter Fahrenheit Temperature:72
22.2222222222
```

```
python fahren.py
Enter Fahrenheit Temperature:fred
Traceback (most recent call last):
  File "fahren.py", line 2, in <module>
    fahr = float(inp)
ValueError: invalid literal for float(): fred
```

There is a conditional execution structure built into Python to handle these types of expected and unexpected errors called “try / except”. The idea of try and except is that you know that some sequence of instruction(s) may have a problem and you want to add some statements to be executed if an error occurs. These extra statements (the except block) is ignored if there is no error.

You can think of the try and except feature in Python as an “insurance policy” on a sequence of statements.

We can rewrite our temperature converter as follows:

```
inp = raw_input('Enter Fahrenheit Temperature:')
try:
    fahr = float(inp)
    cel = (fahr - 32.0) * 5.0 / 9.0
    print cel
except:
    print 'Please enter a number'
```

Python starts by executing the sequence of statements in the try block. If all goes well, it skips the except block and proceeds. If an exception occurs in the try block, Python jumps out of the try block and executes the sequence of statements in the except block.

Handling an exception with a `try` statement is called **catching** an exception. In this example, the `except` clause prints an error message. In general, catching an exception gives you a chance to fix the problem, or try again, or at least end the program gracefully.

3.8 Short circuit evaluation of logical expressions

When Python is processing a logical expression such as `x >= 2 and (x/y) > 2`, it evaluates the expression from left-to-right. Because of the definition of `and`, if `x` is less than 2, the expression `x >= 2` is `False` and so the whole expression is `False` regardless of whether `(x/y) > 2` evaluates to `True` or `False`.

When Python detects that there is nothing to be gained by evaluating the rest of a logical expression, it stops its evaluation and does not do the computations in the rest of the logical expression. When the evaluation of a logical expression stops because the overall value is already known, it is called **short-circuiting** the evaluation.

While this may seem like a fine point, the short circuit behavior leads to a clever technique called the **guardian pattern**. Consider the following code sequence in the Python interpreter:

```
>>> x = 6
>>> y = 2
>>> x >= 2 and (x/y) > 2
True
>>> x = 1
>>> y = 0
>>> x >= 2 and (x/y) > 2
False
>>> x = 6
>>> y = 0
>>> x >= 2 and (x/y) > 2
Traceback (most recent call last):
  File "<stdin>", line 1, in <module>
ZeroDivisionError: integer division or modulo by zero
>>>
```

The third calculation failed because Python was evaluating `(x/y)` and `y` was zero which causes a runtime error. But the second example did *not* fail because the first part of the expression `x >= 2` evaluated to `False` so the `(x/y)` was not ever executed due to the **short circuit** rule and there was no error.

We can construct the logical expression to strategically place a **guard** evaluation just before the evaluation that might cause an error as follows:

```
>>> x = 1
>>> y = 0
>>> x >= 2 and y != 0 and (x/y) > 2
```

```
False
>>> x = 6
>>> y = 0
>>> x >= 2 and y != 0 and (x/y) > 2
False
>>> x >= 2 and (x/y) > 2 and y != 0
Traceback (most recent call last):
  File "<stdin>", line 1, in <module>
ZeroDivisionError: integer division or modulo by zero
>>>
```

In the first logical expression, $x \geq 2$ is `False` so the evaluation stops at the `and`. In the second logical expression $x \geq 2$ is `True` but $y \neq 0$ is `False` so we never reach (x/y) .

In the third logical expression, the $y \neq 0$ is *after* the (x/y) calculation so the expression fails with an error.

In the second expression, we say that $y \neq 0$ acts as a **guard** to insure that we only execute (x/y) if y is non-zero.

3.9 Debugging

The traceback Python displays when an error occurs contains a lot of information, but it can be overwhelming, especially when there are many frames on the stack. The most useful parts are usually:

- What kind of error it was, and
- Where it occurred.

Syntax errors are usually easy to find, but there are a few gotchas. Whitespace errors can be tricky because spaces and tabs are invisible and we are used to ignoring them.

```
>>> x = 5
>>> y = 6
      File "<stdin>", line 1
        y = 6
         ^
SyntaxError: invalid syntax
```

In this example, the problem is that the second line is indented by one space. But the error message points to `y`, which is misleading. In general, error messages indicate where the problem was discovered, but the actual error might be earlier in the code, sometimes on a previous line.

The same is true of runtime errors. Suppose you are trying to compute a signal-to-noise ratio in decibels. The formula is $SNR_{db} = 10 \log_{10}(P_{signal}/P_{noise})$. In Python, you might write something like this:

```
import math
signal_power = 9
noise_power = 10
ratio = signal_power / noise_power
decibels = 10 * math.log10(ratio)
print decibels
```

But when you run it, you get an error message¹:

```
Traceback (most recent call last):
  File "snr.py", line 5, in ?
    decibels = 10 * math.log10(ratio)
OverflowError: math range error
```

The error message indicates line 5, but there is nothing wrong with that line. To find the real error, it might be useful to print the value of `ratio`, which turns out to be 0. The problem is in line 4, because dividing two integers does floor division. The solution is to represent signal power and noise power with floating-point values.

In general, error messages tell you where the problem was discovered, but that is often not where it was caused.

3.10 Glossary

boolean expression: An expression whose value is either `True` or `False`.

comparison operator: One of the operators that compares its operands: `==`, `!=`, `>`, `<`, `>=`, and `<=`.

logical operator: One of the operators that combines boolean expressions: `and`, `or`, and `not`.

conditional statement: A statement that controls the flow of execution depending on some condition.

condition: The boolean expression in a conditional statement that determines which branch is executed.

compound statement: A statement that consists of a header and a body. The header ends with a colon (`:`). The body is indented relative to the header.

body: The sequence of statements within a compound statement.

branch: One of the alternative sequences of statements in a conditional statement.

chained conditional: A conditional statement with a series of alternative branches.

¹In Python 3.0, you no longer get an error message; the division operator performs floating-point division even with integer operands.

nested conditional: A conditional statement that appears in one of the branches of another conditional statement.

traceback: A list of the functions that are executing, printed when an exception occurs.

short circuit: When Python is part-way through evaluating a logical expression and stops the evaluation because Python knows the final value for the expression without needing to evaluate the rest of the expression.

guardian pattern: Where we construct a logical expression with additional comparisons to take advantage of the short circuit behavior.

3.11 Exercises

Exercise 3.1 Rewrite your pay computation to give the employee 1.5 times the hourly rate for hours worked above 40 hours.

```
Enter Hours: 45
Enter Rate: 10
Pay: 475.0
```

Exercise 3.2 Rewrite your pay program using `try` and `except` so that your program handles non-numeric input gracefully by printing a message and exiting the program. The following shows two executions of the program:

```
Enter Hours: 20
Enter Rate: nine
Error, please enter numeric input
```

```
Enter Hours: forty
Error, please enter numeric input
```

Exercise 3.3 Write a program to prompt for a score between 0.0 and 1.0. If the score is out of range print an error. If the score is between 0.0 and 1.0, print a grade using the following table:

Score	Grade
> 0.9	A
> 0.8	B
> 0.7	C
> 0.6	D
<= 0.6	F

```
Enter score: 0.95
A
```

```
Enter score: perfect
Bad score
```

```
Enter score: 10.0  
Bad score
```

```
Enter score: 0.75  
C
```

```
Enter score: 0.5  
F
```

Run the program repeatedly as shown above to test the various different values for input.

Chapter 4

Functions

4.1 Function calls

In the context of programming, a **function** is a named sequence of statements that performs a computation. When you define a function, you specify the name and the sequence of statements. Later, you can “call” the function by name. We have already seen one example of a **function call**:

```
>>> type(32)
<type 'int'>
```

The name of the function is `type`. The expression in parentheses is called the **argument** of the function. The argument is a value or variable that we are passing into the function as input of the function. The result, for the `type` function, is the type of the argument.

It is common to say that a function “takes” an argument and “returns” a result. The result is called the **return value**.

4.2 Built-in functions

Python provides a number of important built-in functions that we can use without needing to provide the function definition. In a sense, the creators of Python wrote a set of functions to solve common problems and included them in Python for us to use.

The `max` and `min` functions give us the largest and smallest values in a list, respectively:

```
>>> max('Hello world')
'w'
>>> min('Hello world')
' '
>>>
```

The `max` function tells us the “largest character” in the string (which turns out to be the letter “w”) and the `min` function shows us the smallest character which turns out to be a space.

Another very common built-in function is the `len` function which tells us how many items are in its argument. If the argument to `len` is a string, it returns the number of characters in the string.

```
>>> len('Hello world')
11
>>>
```

These functions are not limited to looking at strings, they can operate on any set of values as we will see in later chapters.

4.3 Type conversion functions

Python also provides built-in functions that convert values from one type to another. The `int` function takes any value and converts it to an integer, if it can, or complains otherwise:

```
>>> int('32')
32
>>> int('Hello')
ValueError: invalid literal for int(): Hello
```

`int` can convert floating-point values to integers, but it doesn't round off; it chops off the fraction part:

```
>>> int(3.99999)
3
>>> int(-2.3)
-2
```

`float` converts integers and strings to floating-point numbers:

```
>>> float(32)
32.0
>>> float('3.14159')
3.14159
```

Finally, `str` converts its argument to a string:

```
>>> str(32)
'32'
>>> str(3.14159)
'3.14159'
```

4.4 Random numbers

Given the same inputs, most computer programs generate the same outputs every time, so they are said to be **deterministic**. Determinism is usually a good thing, since we expect the same calculation to yield the same result. For some applications, though, we want the computer to be unpredictable. Games are an obvious example, but there are more.

Making a program truly nondeterministic turns out to be not so easy, but there are ways to make it at least seem nondeterministic. One of them is to use algorithms that generate **pseudorandom** numbers. Pseudorandom numbers are not truly random because they are generated by a deterministic computation, but just by looking at the numbers it is all but impossible to distinguish them from random.

The `random` module provides functions that generate pseudorandom numbers (which I will simply call “random” from here on).

The function `random` returns a random float between 0.0 and 1.0 (including 0.0 but not 1.0). Each time you call `random`, you get the next number in a long series. To see a sample, run this loop:

```
import random

for i in range(10):
    x = random.random()
    print x
```

The function `randint` takes parameters `low` and `high` and returns an integer between `low` and `high` (including both).

```
>>> random.randint(5, 10)
5
>>> random.randint(5, 10)
9
```

To choose an element from a sequence at random, you can use `choice`:

```
>>> t = [1, 2, 3]
>>> random.choice(t)
2
>>> random.choice(t)
3
```

The `random` module also provides functions to generate random values from continuous distributions including Gaussian, exponential, gamma, and a few more.

4.5 Optional parameters

We have seen built-in functions and methods that take a variable number of arguments. It is possible to write user-defined functions with optional arguments, too. For example, here is a function that prints the most common words in a histogram

```
def print_most_common(hist, num=10)
    t = most_common(hist)
    print 'The most common words are:'
    for freq, word in t[0:num]:
        print word, '\t', freq
```

The first parameter is required; the second is optional. The **default value** of `num` is 10.

If you only provide one argument:

```
print_most_common(hist)
```

`num` gets the default value. If you provide two arguments:

```
print_most_common(hist, 20)
```

`num` gets the value of the argument instead. In other words, the optional argument **overrides** the default value.

If a function has both required and optional parameters, all the required parameters have to come first, followed by the optional ones.

4.6 Glossary

deterministic: Pertaining to a program that does the same thing each time it runs, given the same inputs.

pseudorandom: Pertaining to a sequence of numbers that appear to be random, but are generated by a deterministic program.

4.7 Math functions

Python has a `math` **module** that provides most of the familiar mathematical functions. Before we can use the module, we have to import it:

```
>>> import math
```

This statement creates a **module object** named `math`. If you print the module object, you get some information about it:

```
>>> print math
<module 'math' from '/usr/lib/python2.5/lib-dynload/math.so'>
```

The module object contains the functions and variables defined in the module. To access one of the functions, you have to specify the name of the module and the name of the function, separated by a dot (also known as a period). This format is called **dot notation**.

```
>>> ratio = signal_power / noise_power
>>> decibels = 10 * math.log10(ratio)
```

```
>>> radians = 0.7
>>> height = math.sin(radians)
```

The first example computes the logarithm base 10 of the signal-to-noise ratio. The `math` module also provides a function called `log` that computes logarithms base e .

The second example finds the sine of radians. The name of the variable is a hint that `sin` and the other trigonometric functions (`cos`, `tan`, etc.) take arguments in radians. To convert from degrees to radians, divide by 360 and multiply by 2π :

```
>>> degrees = 45
>>> radians = degrees / 360.0 * 2 * math.pi
>>> math.sin(radians)
0.707106781187
```

The expression `math.pi` gets the variable `pi` from the `math` module. The value of this variable is an approximation of π , accurate to about 15 digits.

If you know your trigonometry, you can check the previous result by comparing it to the square root of two divided by two:

```
>>> math.sqrt(2) / 2.0
0.707106781187
```

4.8 Adding new functions

So far, we have only been using the functions that come with Python, but it is also possible to add new functions. A **function definition** specifies the name of a new function and the sequence of statements that execute when the function is called. Once we define a function, we can reuse the function over and over throughout our program.

Here is an example:

```
def print_lyrics():
    print "I'm a lumberjack, and I'm okay."
    print 'I sleep all night and I work all day.'
```

`def` is a keyword that indicates that this is a function definition. The name of the function is `print_lyrics`. The rules for function names are the same as for variable names: letters, numbers and some punctuation marks are legal, but the first character can't be a number. You can't use a keyword as the name of a function, and you should avoid having a variable and a function with the same name.

The empty parentheses after the name indicate that this function doesn't take any arguments. Later will build functions that take arguments as their inputs.

The first line of the function definition is called the **header**; the rest is called the **body**. The header has to end with a colon and the body has to be indented. By convention, the indentation is always four spaces (see Section 4.14). The body can contain any number of statements.

The strings in the print statements are enclosed in double quotes. Single quotes and double quotes do the same thing; most people use single quotes except in cases like this where a single quote (which is also an apostrophe) appears in the string.

If you type a function definition in interactive mode, the interpreter prints ellipses (...) to let you know that the definition isn't complete:

```
>>> def print_lyrics():
...     print "I'm a lumberjack, and I'm okay."
...     print 'I sleep all night and I work all day.'
... 
```

To end the function, you have to enter an empty line (this is not necessary in a script).

Defining a function creates a variable with the same name.

```
>>> print print_lyrics
<function print_lyrics at 0xb7e99e9c>
>>> print type(print_lyrics)
<type 'function'>
```

The value of `print_lyrics` is a **function object**, which has type `'function'`.

The syntax for calling the new function is the same as for built-in functions:

```
>>> print_lyrics()
I'm a lumberjack, and I'm okay.
I sleep all night and I work all day.
```

Once you have defined a function, you can use it inside another function. For example, to repeat the previous refrain, we could write a function called `repeat_lyrics`:

```
def repeat_lyrics():
    print_lyrics()
    print_lyrics()
```

And then call `repeat_lyrics`:

```
>>> repeat_lyrics()
I'm a lumberjack, and I'm okay.
I sleep all night and I work all day.
I'm a lumberjack, and I'm okay.
I sleep all night and I work all day.
```

But that's not really how the song goes.

4.9 Definitions and uses

Pulling together the code fragments from the previous section, the whole program looks like this:

```
def print_lyrics():
    print "I'm a lumberjack, and I'm okay."
    print 'I sleep all night and I work all day.'

def repeat_lyrics():
    print_lyrics()
    print_lyrics()

repeat_lyrics()
```

This program contains two function definitions: `print_lyrics` and `repeat_lyrics`. Function definitions get executed just like other statements, but the effect is to create function objects. The statements inside the function do not get executed until the function is called, and the function definition generates no output.

As you might expect, you have to create a function before you can execute it. In other words, the function definition has to be executed before the first time it is called.

Exercise 4.1 Move the last line of this program to the top, so the function call appears before the definitions. Run the program and see what error message you get.

Exercise 4.2 Move the function call back to the bottom and move the definition of `print_lyrics` after the definition of `repeat_lyrics`. What happens when you run this program?

4.10 Flow of execution

In order to ensure that a function is defined before its first use, you have to know the order in which statements are executed, which is called the **flow of execution**.

Execution always begins at the first statement of the program. Statements are executed one at a time, in order from top to bottom.

Function *definitions* do not alter the flow of execution of the program, but remember that statements inside the function are not executed until the function is called.

A function call is like a detour in the flow of execution. Instead of going to the next statement, the flow jumps to the body of the function, executes all the statements there, and then comes back to pick up where it left off.

That sounds simple enough, until you remember that one function can call another. While in the middle of one function, the program might have to execute the statements in another function. But while executing that new function, the program might have to execute yet another function!

Fortunately, Python is good at keeping track of where it is, so each time a function completes, the program picks up where it left off in the function that called it. When it gets to the end of the program, it terminates.

What's the moral of this sordid tale? When you read a program, you don't always want to read from top to bottom. Sometimes it makes more sense if you follow the flow of execution.

4.11 Parameters and arguments

Some of the built-in functions we have seen require arguments. For example, when you call `math.sin` you pass a number as an argument. Some functions take more than one argument: `math.pow` takes two, the base and the exponent.

Inside the function, the arguments are assigned to variables called **parameters**. Here is an example of a user-defined function that takes an argument:

```
def print_twice(bruce):
    print bruce
    print bruce
```

This function assigns the argument to a parameter named `bruce`. When the function is called, it prints the value of the parameter (whatever it is) twice.

This function works with any value that can be printed.

```
>>> print_twice('Spam')
Spam
Spam
>>> print_twice(17)
17
17
>>> print_twice(math.pi)
3.14159265359
3.14159265359
```

The same rules of composition that apply to built-in functions also apply to user-defined functions, so we can use any kind of expression as an argument for `print_twice`:

```
>>> print_twice('Spam '*4)
Spam Spam Spam Spam
Spam Spam Spam Spam
>>> print_twice(math.cos(math.pi))
-1.0
-1.0
```

The argument is evaluated before the function is called, so in the examples the expressions `'Spam '*4` and `math.cos(math.pi)` are only evaluated once.

You can also use a variable as an argument:

```
>>> michael = 'Eric, the half a bee.'
>>> print_twice(michael)
Eric, the half a bee.
Eric, the half a bee.
```

The name of the variable we pass as an argument (`michael`) has nothing to do with the name of the parameter (`bruce`). It doesn't matter what the value was called back home (in the caller); here in `print_twice`, we call everybody `bruce`.

4.12 Fruitful functions and void functions

Some of the functions we are using, such as the math functions, yield results; for lack of a better name, I call them **fruitful functions**. Other functions, like `print_twice`, perform an action but don't return a value. They are called **void functions**.

When you call a fruitful function, you almost always want to do something with the result; for example, you might assign it to a variable or use it as part of an expression:

```
x = math.cos(radians)
golden = (math.sqrt(5) + 1) / 2
```

When you call a function in interactive mode, Python displays the result:

```
>>> math.sqrt(5)
2.2360679774997898
```

But in a script, if you call a fruitful function and do not store the result of the function in a variable, the return value vanishes into the mist!

```
math.sqrt(5)
```

This script computes the square root of 5, but since it doesn't store the result in a variable or display the result, it is not very useful.

Void functions might display something on the screen or have some other effect, but they don't have a return value. If you try to assign the result to a variable, you get a special value called `None`.

```
>>> result = print_twice('Bing')
Bing
Bing
>>> print result
None
```

The value `None` is not the same as the string `'None'`. It is a special value that has its own type:

```
>>> print type(None)
<type 'NoneType'>
```

To return a result from a function, we use the `return` statement in our function. For example, we could make a very simple function called `addtwo` that adds two numbers together and return a result.

```
def addtwo(a, b):
    added = a + b
    return added
```

```
x = addtwo(3, 5)
print x
```

When this script executes, the `print` statement will print out “8” because the `addtwo` function was called with 3 and 5 as arguments. Within the function the parameters `a` and `b` were 3 and 5 respectively. The function computed the sum of the two numbers and placed it in the local function variable named `added` and used the `return` statement to send the computed value back to the calling code as the function result which was assigned to the variable `x` and printed out.

4.13 Why functions?

It may not be clear why it is worth the trouble to divide a program into functions. There are several reasons:

- Creating a new function gives you an opportunity to name a group of statements, which makes your program easier to read, understand and debug.
- Functions can make a program smaller by eliminating repetitive code. Later, if you make a change, you only have to make it in one place.
- Dividing a long program into functions allows you to debug the parts one at a time and then assemble them into a working whole.
- Well-designed functions are often useful for many programs. Once you write and debug one, you can reuse it.

Throughout the rest of the book, we often will use a function definition to explain a concept. Part of the skill of creating and using functions is to have a function properly capture an idea such as “find the smallest value in a list of values”. Later we will show you code that finds the smallest in a list of values and we will present it to you as a function named `min` which takes a list of values as its argument and returns the smallest value in the list.

4.14 Debugging

If you are using a text editor to write your scripts, you might run into problems with spaces and tabs. The best way to avoid these problems is to use spaces exclusively (no tabs). Most text editors that know about Python do this by default, but some don't.

Tabs and spaces are usually invisible, which makes them hard to debug, so try to find an editor that manages indentation for you.

Also, don't forget to save your program before you run it. Some development environments do this automatically, but some don't. In that case the program you are looking at in the text editor is not the same as the program you are running.

Debugging can take a long time if you keep running the same, incorrect, program over and over!

Make sure that the code you are looking at is the code you are running. If you're not sure, put something like `print 'hello'` at the beginning of the program and run it again. If you don't see `hello`, you're not running the right program!

4.15 Glossary

function: A named sequence of statements that performs some useful operation. Functions may or may not take arguments and may or may not produce a result.

function definition: A statement that creates a new function, specifying its name, parameters, and the statements it executes.

function object: A value created by a function definition. The name of the function is a variable that refers to a function object.

header: The first line of a function definition.

body: The sequence of statements inside a function definition.

parameter: A name used inside a function to refer to the value passed as an argument.

function call: A statement that executes a function. It consists of the function name followed by an argument list.

argument: A value provided to a function when the function is called. This value is assigned to the corresponding parameter in the function.

return value: The result of a function. If a function call is used as an expression, the return value is the value of the expression.

fruitful function: A function that returns a value.

void function: A function that doesn't return a value.

import statement: A statement that reads a module file and creates a module object.

module object: A value created by an `import` statement that provides access to the data and code defined in a module.

dot notation: The syntax for calling a function in another module by specifying the module name followed by a dot (period) and the function name.

composition: Using an expression as part of a larger expression, or a statement as part of a larger statement.

flow of execution: The order in which statements are executed during a program run.

4.16 Exercises

Exercise 4.3 Rewrite your pay computation with time-and-a-half for overtime and create a function called `compute_pay` which takes two parameters (hours and rate).

```
Enter Hours: 45
Enter Rate: 10
Pay: 475.0
```

Exercise 4.4 Rewrite the grade program from the previous chapter using a function called `compute_grade` that takes a score as its parameter and returns a grade as a string.

```
Score  Grade
> 0.9   A
> 0.8   B
> 0.7   C
> 0.6   D
<= 0.6  F
```

Program Execution:

```
Enter score: 0.95
A
```

```
Enter score: perfect
Bad score
```

```
Enter score: 10.0
Bad score
```

```
Enter score: 0.75
C
```

```
Enter score: 0.5
F
```

Run the program repeatedly to test the various different values for input.

Chapter 5

Iteration

5.1 Updating variables

One of the most common forms of multiple assignment is an **update**, where the new value of the variable depends on the old.

```
x = x+1
```

This means “get the current value of *x*, add one, and then update *x* with the new value.”

If you try to update a variable that doesn't exist, you get an error, because Python evaluates the right side before it assigns a value to *x*:

```
>>> x = x+1
NameError: name 'x' is not defined
```

Before you can update a variable, you have to **initialize** it, usually with a simple assignment:

```
>>> x = 0
>>> x = x+1
```

Updating a variable by adding 1 is called an **increment**; subtracting 1 is called a **decrement**.

5.2 The while statement

Computers are often used to automate repetitive tasks. Repeating identical or similar tasks without making errors is something that computers do well and people do poorly. Because iteration is so common, Python provides several language features to make it easier.

One form of iteration in Python is the `while` statement. Here is a simple program that counts down from five and then says “Blastoff!”.

```
n = 5
while n > 0:
    print n
    n = n-1
print 'Blastoff!'
```

You can almost read the `while` statement as if it were English. It means, “While `n` is greater than 0, display the value of `n` and then reduce the value of `n` by 1. When you get to 0, exit the `while` statement and display the word `Blastoff!`”

More formally, here is the flow of execution for a `while` statement:

1. Evaluate the condition, yielding `True` or `False`.
2. If the condition is false, exit the `while` statement and continue execution at the next statement.
3. If the condition is true, execute the body and then go back to step 1.

This type of flow is called a **loop** because the third step loops back around to the top. Each time we execute the body of the loop, we call it an **iteration**. For the above loop, we would say, “It had five iterations” which means that the body of the loop was executed five times.

The body of the loop should change the value of one or more variables so that eventually the condition becomes false and the loop terminates. We call the variable that changes each time the loop executes and controls when the loop finishes the **iteration variable**. If there is no iteration variable, the loop will repeat forever, resulting in an **infinite loop**.

5.3 Infinite loops

An endless source of amusement for programmers is the observation that the directions on shampoo, “Lather, rinse, repeat,” are an infinite loop because there is no **iteration variable** telling you how many times to execute the loop.

In the case of countdown, we can prove that the loop terminates because we know that the value of `n` is finite, and we can see that the value of `n` gets smaller each time through the loop, so eventually we have to get to 0. Other times a loop is obviously infinite because it has no iteration variable at all.

In other cases, it is not so easy to tell. The code below defines a function that takes an positive number as its parameter and computes a different kind of sequence. Remember that the percent sign is the **modulo** operator which gives us the remainder if a division were performed.

```
def sequence(n):
    while n != 1:
        print n,          # Use comma to suppress newline
```

```

    if n%2 == 0:          # n is even
        n = n/2
    else:                # n is odd
        n = n*3+1

```

XXX The condition for this loop is $n \neq 1$ ¹, so the loop will continue until n is 1, which makes the condition false.

Each time through the loop, the program outputs the value of n and then checks whether it is even or odd. If it is even, n is divided by 2. If it is odd, the value of n is replaced with $n*3+1$. For example, if the argument passed to `sequence` is 3, the resulting sequence is 3, 10, 5, 16, 8, 4, 2, 1.

Since n sometimes increases and sometimes decreases, there is no obvious proof that n will ever reach 1, or that the program terminates. For some particular values of n , we can prove termination. For example, if the starting value is a power of two, then the value of n will be even each time through the loop until it reaches 1. The previous example ends with such a sequence, starting with 16.

```

>>> def sequence(n):
...     while n != 1:
...         print n,
...         if n%2 == 0:          # n is even
...             n = n/2
...         else:                # n is odd
...             n = n*3+1
...
>>> sequence(3)
3 10 5 16 8 4 2
>>> sequence(16)
16 8 4 2
>>> sequence(50)
50 25 76 38 19 58 29 88 44 22 11 34 17 52 26 13 40 20 10 5 16 8 4 2

```

You can try this sequence with a variety of integer or floating point numbers as the argument. Since the main loop repeatedly divides a number by two, an argument in the billions converges to one in relatively few steps. It is more fun to try floating point arguments such as 12.45 as it takes more iterations before the sequence converges to one.

The hard question is whether we can prove that this program terminates for *all positive values* of n . So far², no one has been able to prove it *or* disprove it!

5.4 “Infinite loops” and break

Sometimes you don’t know it’s time to end a loop until you get half way through the body. In that case you can write an infinite loop on purpose and then use the `break` statement to

¹Remember that `!=` is the operator for ‘not equal’.

²See wikipedia.org/wiki/Collatz_conjecture.

jump out of the loop.

This loop is obviously an **infinite loop** because the logical expression on the `while` statement is simply the logical constant `True`:

```
n = 10
while True:
    print n,
    n = n - 1
print 'Done!'
```

If you make the mistake and run this code, you will learn quickly how to stop a runaway Python process on your system or find where the power-off button is on your computer. This program will run forever or until your battery runs out because the logical expression at the top of the loop is always true by virtue of the fact that the expression is the constant value `True`.

While this is a dysfunctional infinite loop, we can still use this pattern to build useful loops as long as we carefully add code to the body of the loop to explicitly exit the loop using `break` when we have reached the exit condition.

For example, suppose you want to take input from the user until they type `done`. You could write:

```
while True:
    line = raw_input('> ')
    if line == 'done':
        break
    print line
print 'Done!'
```

The loop condition is `True`, which is always true, so the loop runs repeatedly until it hits the `break` statement.

Each time through, it prompts the user with an angle bracket. If the user types `done`, the `break` statement exits the loop. Otherwise the program echoes whatever the user types and goes back to the top of the loop. Here's a sample run:

```
> hello there
hello there
> finished
finished
> done
Done!
```

This way of writing `while` loops is common because you can check the condition anywhere in the loop (not just at the top) and you can express the stop condition affirmatively (“stop when this happens”) rather than negatively (“keep going until that happens.”).

5.5 Finishing iterations with `continue`

Sometimes you are in an iteration of a loop and want to finish the current iteration and immediately jump to the next iteration. In that case you can use the `continue` statement to skip to the next iteration without finishing the body of the loop for the current iteration.

Here is an example of a loop that copies its input until the user types “done”, but treats lines that start with the hash character as lines not to be printed (kind of like Python comments).

```
while True:
    line = raw_input('> ')
    if line[0] == '#':
        continue
    if line == 'done':
        break
    print line
print 'Done!'
```

Here is a sample run of this new program with `continue` added.

```
> hello there
hello there
> # don't print this
> print this!
print this!
> done
Done!
```

All the lines are printed except the one that starts with the hash sign because when the `continue` is executed, it ends the current iteration and jumps back to the `while` statement to start the next iteration, thus skipping the `print` statement.

5.6 Definite loops using `for`

Sometimes we want to loop through a **set** of things such as a list of words, the lines in a file or a list of numbers. When we have a list of things to loop through, we can construct a *definite* loop using a `for` statement. We call the `while` statement an *indefinite* loop because it simply loops until some condition becomes `False` whereas the `for` loop is looping through a known set of items so it runs through as many iterations as there are items in the set.

The syntax of a `for` loop is similar to the `while` loop in that there is a `for` statement and a loop body:

```
friends = ['Joseph', 'Glenn', 'Sally']
for friend in friends:
    print 'Happy New Year:', friend
print 'Done!'
```

Translating this `for` loop to English is not as direct as the `while`, but if you think of friends as a **set**, it goes like this: “Run the statements in the body of the `for` loop once for each friend *in* the set named `friends`.”.

In Python terms, the variable `friends` is a list³ of three strings and the `for` loop goes through the list and executes the body once for each of the three strings in the list resulting in this output:

```
Happy New Year: Joseph
Happy New Year: Glenn
Happy New Year: Sally
Done!
```

Looking at the `for` loop, **`for`** and **`in`** are reserved Python keywords, and `friend` and `friends` are variables.

```
for friend in friends:
    print 'Happy New Year', friend
```

In particular, `friend` is the **iteration variable** for the `for` loop. The variable `friend` changes for each iteration of the loop and controls when the `for` loop completes. The **iteration variable** steps successively through the three strings stored in the `friends` variable.

5.7 Loop patterns

Often we use a `for` or `while` loop to go through a list of items or the contents of a file and we are looking for something such as the largest or smallest value of the data we scan through.

These loops are generally constructed by:

- Initialize one or more variables before the loop starts.
- Perform some computation on each item in the loop body, possibly changing the variables in the body of the loop
- At the end of the loop, the variables contain the information we are looking for

We will use a list of numbers to demonstrate the concepts and construction of these loop patterns.

5.7.1 Counting and summing loops

For example, to count the number of items in a list, we would write the following `for` loop:

³We will examine lists in more detail in a later chapter

```
count = 0
for interval in [3, 41, 12, 9, 74, 15]:
    count = count + 1
print 'Count: ', count
```

We set the variable `count` to zero before the loop starts, then we write a `for` loop to run through the list of numbers. Our **iteration** variable is named `interval` and while we do not use `interval` in the loop, it does control the loop and cause the loop body to be executed once for each of the values in the list.

In the body of the loop, we add one to the current value of `count` for each of the values in the list. While the loop is executing, the value of `count` is the number of values we have seen “so far”.

Once the loop completes, the value of `count` is the total number of items. The total number “falls in our lap” at the end of the loop. We construct the loop so that we have what we want when the loop finishes.

Another similar loop that computes the total of a set of numbers is as follows:

```
total = 0
for interval in [3, 41, 12, 9, 74, 15]:
    total = total + interval
print 'Total: ', total
```

In this loop we *do* use the **iteration variable**. Instead of simply adding one to the count as in the previous loop, we add the actual number (3, 41, 12, etc.) to the running total during each loop iteration. If you think about the variable `total`, it contains the “running total of the values so far”. So before the loop starts `total` is zero because we have not yet seen any values, during the loop `total` is the running total, and at the end of the loop `total` is the overall total of all the values in the list.

As the loop executes, `total` accumulates the sum of the elements; a variable used this way is sometimes called an **accumulator**.

Neither the counting loop nor the summing loop are particularly useful in practice because there are built-in functions `len()` and `sum()` that compute the number of items in a list and the total of the items in the list respectively.

5.7.2 Maximum and minimum loops

To find the largest value in a list or sequence, we construct the following loop:

```
largest = None
print 'Before:', largest
for interval in [3, 41, 12, 9, 74, 15]:
    if largest == None or largest < interval:
        largest = interval
    print 'Loop:', interval, largest
print 'Largest:', largest
```

When the program executes, the output is as follows:

```
Before: None
Loop: 3 3
Loop: 41 41
Loop: 12 41
Loop: 9 41
Loop: 74 74
Loop: 15 74
Largest: 74
```

The variable `largest` is best thought of as the “largest value we have seen so far”. Before the loop, we set `largest` to the constant `None`. `None` is a special constant value which we can store in a variable to mark the variable as “empty”.

Before the loop starts, the largest value we have seen so far is `None` since we have not yet seen any values. While the loop is executing, if `largest` is `None` then we take the first value we see as the largest so far. You can see in the first iteration when the value of `interval` is 3, since `largest` is `None`, we immediately set `largest` to be 3.

After the first iteration, `largest` is no longer `None`, so the second part of the compound logical expression that checks `largest < interval` triggers only when we see a value that is larger than the “largest so far”. When we see a new “even larger” value we take that new value for `largest`. You can see in the program output that `largest` progresses from 3 to 41 to 74.

At the end of the loop, we have scanned all of the values and the variable `largest` now does contain the largest value in the list.

To compute the smallest number, the code is very similar with one small change:

```
smallest = None
print 'Before:', smallest
for interval in [3, 41, 12, 9, 74, 15]:
    if smallest == None or interval < smallest:
        smallest = interval
    print 'Loop:', interval, smallest
print 'Smallest:', smallest
```

Again, `smallest` is the “smallest so far” before, during, and after the loop executes. When the loop has completed, `smallest` contains the minimum value in the list.

Again as in counting and summing, the built-in functions `max()` and `min()` make writing these exact loops unnecessary.

The following is a simple version of the Python built-in `min()` function:

```
def min(values):
    smallest = None
    for value in values:
```

```
    if smallest == None or value < smallest:
        smallest = interval
return smallest
```

In the function version of the `smallest` code, we removed all of the `print` statements so as to be equivalent to the `min` function which is already built-in to Python.

5.8 Debugging

As you start writing bigger programs, you might find yourself spending more time debugging. More code means more chances to make an error and more places for bugs to hide.

One way to cut your debugging time is “debugging by bisection.” For example, if there are 100 lines in your program and you check them one at a time, it would take 100 steps.

Instead, try to break the problem in half. Look at the middle of the program, or near it, for an intermediate value you can check. Add a `print` statement (or something else that has a verifiable effect) and run the program.

If the mid-point check is incorrect, the problem must be in the first half of the program. If it is correct, the problem is in the second half.

Every time you perform a check like this, you halve the number of lines you have to search. After six steps (which is much less than 100), you would be down to one or two lines of code, at least in theory.

In practice it is not always clear what the “middle of the program” is and not always possible to check it. It doesn’t make sense to count lines and find the exact midpoint. Instead, think about places in the program where there might be errors and places where it is easy to put a check. Then choose a spot where you think the chances are about the same that the bug is before or after the check.

5.9 Glossary

multiple assignment: Making more than one assignment to the same variable during the execution of a program.

update: An assignment where the new value of the variable depends on the old.

initialize: An assignment that gives an initial value to a variable that will be updated.

increment: An update that increases the value of a variable (often by one).

decrement: An update that decreases the value of a variable.

iteration: Repeated execution of a set of statements using either a recursive function call or a loop.

counter: A variable used in a loop to count the number of times something happened. We initialize a counter to zero and then increment the counter each time we want to “count” something.

accumulator: A variable used in a loop to add up or accumulate a result.

infinite loop: A loop in which the terminating condition is never satisfied or for which there is no termination condition.

5.10 Exercises

Exercise 5.1 Write a program which reads list of numbers until “done” is entered. Once “done” is entered, print out the total, count, and average of the numbers. If the user enters anything other than a number, detect their mistake using `try` and `catch` and print an error message and skip to the next number.

```
Enter a number: 4
Enter a number: 5
Enter a number: bad data
Invalid input
Enter a number: 7
Enter a number: done
Average: 5.3333333333
```

Exercise 5.2 Write another program that prompts for a list of numbers as above and at the end prints out both the maximum and minimum of the numbers.

Chapter 6

Strings

6.1 A string is a sequence

A string is a **sequence** of characters. You can access the characters one at a time with the bracket operator:

```
>>> fruit = 'banana'
>>> letter = fruit[1]
```

The second statement extracts the character at index position 1 from the `fruit` variable and assigns it to `letter` variable.

The expression in brackets is called an **index**. The index indicates which character in the sequence you want (hence the name).

But you might not get what you expect:

```
>>> print letter
a
```

For most people, the first letter of 'banana' is b, not a. But in Python, the index is an offset from the beginning of the string, and the offset of the first letter is zero.

```
>>> letter = fruit[0]
>>> print letter
b
```

So b is the 0th letter (“zero-eth”) of 'banana', a is the 1th letter (“one-eth”), and n is the 2th (“two-eth”) letter.

You can use any expression, including variables and operators, as an index, but the value of the index has to be an integer. Otherwise you get:

```
>>> letter = fruit[1.5]
TypeError: string indices must be integers
```

6.2 Getting the length of a string using `len`

`len` is a built-in function that returns the number of characters in a string:

```
>>> fruit = 'banana'
>>> len(fruit)
6
```

To get the last letter of a string, you might be tempted to try something like this:

```
>>> length = len(fruit)
>>> last = fruit[length]
IndexError: string index out of range
```

The reason for the `IndexError` is that there is no letter in 'banana' with the index 6. Since we started counting at zero, the six letters are numbered 0 to 5. To get the last character, you have to subtract 1 from `length`:

```
>>> last = fruit[length-1]
>>> print last
a
```

Alternatively, you can use negative indices, which count backward from the end of the string. The expression `fruit[-1]` yields the last letter, `fruit[-2]` yields the second to last, and so on.

6.3 Traversal through a string with a `for` loop

A lot of computations involve processing a string one character at a time. Often they start at the beginning, select each character in turn, do something to it, and continue until the end. This pattern of processing is called a **traversal**. One way to write a traversal is with a `while` loop:

```
index = 0
while index < len(fruit):
    letter = fruit[index]
    print letter
    index = index + 1
```

This loop traverses the string and displays each letter on a line by itself. The loop condition is `index < len(fruit)`, so when `index` is equal to the length of the string, the condition is false, and the body of the loop is not executed. The last character accessed is the one with the index `len(fruit)-1`, which is the last character in the string.

Exercise 6.1 Write a `while` loop that starts at the last character in the string and works its way backwards to the first character in the string, printing each letter on a separate line, except backwards.

Another way to write a traversal is with a for loop:

```
for char in fruit:
    print char
```

Each time through the loop, the next character in the string is assigned to the variable `char`. The loop continues until no characters are left.

The following example shows how to use concatenation (string addition) and a for loop to generate an abecedarian series (that is, in alphabetical order). In Robert McCloskey's book *Make Way for Ducklings*, the names of the ducklings are Jack, Kack, Lack, Mack, Nack, Ouack, Pack, and Quack. This loop outputs these names in order:

```
prefixes = 'JKLMNOPQ'
suffix = 'ack'

for letter in prefixes:
    print letter + suffix
```

The output is:

```
Jack
Kack
Lack
Mack
Nack
Oack
Pack
Quack
```

Of course, that's not quite right because "Ouack" and "Quack" are misspelled.

6.4 String slices

A segment of a string is called a **slice**. Selecting a slice is similar to selecting a character:

```
>>> s = 'Monty Python'
>>> print s[0:5]
Monty
>>> print s[6:13]
Python
```

The operator `[n:m]` returns the part of the string from the "n-eth" character to the "m-eth" character, including the first but excluding the last. This behavior is counterintuitive, but it might help to imagine the indices pointing *between* the characters, as in the following diagram:

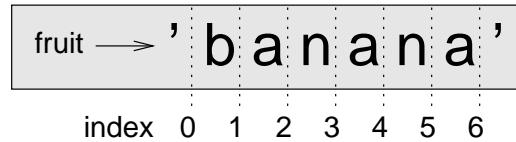

If you omit the first index (before the colon), the slice starts at the beginning of the string. If you omit the second index, the slice goes to the end of the string:

```
>>> fruit = 'banana'
>>> fruit[:3]
'ban'
>>> fruit[3:]
'ana'
```

If the first index is greater than or equal to the second the result is an **empty string**, represented by two quotation marks:

```
>>> fruit = 'banana'
>>> fruit[3:3]
''
```

An empty string contains no characters and has length 0, but other than that, it is the same as any other string.

Exercise 6.2 Given that `fruit` is a string, what does `fruit[:]` mean?

6.5 Strings are immutable

It is tempting to use the `[]` operator on the left side of an assignment, with the intention of changing a character in a string. For example:

```
>>> greeting = 'Hello, world!'
>>> greeting[0] = 'J'
TypeError: object does not support item assignment
```

The “object” in this case is the string and the “item” is the character you tried to assign. For now, an **object** is the same thing as a value, but we will refine that definition later. An **item** is one of the values in a sequence.

The reason for the error is that strings are **immutable**, which means you can’t change an existing string. The best you can do is create a new string that is a variation on the original:

```
>>> greeting = 'Hello, world!'
>>> new_greeting = 'J' + greeting[1:]
>>> print new_greeting
Jello, world!
```

This example concatenates a new first letter onto a slice of `greeting`. It has no effect on the original string.

6.6 Searching

What does the following function do?

```
def find(word, letter):
    index = 0
    while index < len(word):
        if word[index] == letter:
            return index
        index = index + 1
    return -1
```

In a sense, `find` is the opposite of the `[]` operator. Instead of taking an index and extracting the corresponding character, it takes a character and finds the index where that character appears. If the character is not found, the function returns `-1`.

This is the first example we have seen of a `return` statement inside a loop. If `word[index] == letter`, the function breaks out of the loop and returns immediately.

If the character doesn't appear in the string, the loop exits normally at the bottom and returns `-1`.

This pattern of computation—traversing a sequence and returning when we find what we are looking for—is called a **search**.

Exercise 6.3 Modify `find` so that it has a third parameter, the index in `word` where it should start looking.

6.7 Looping and counting

The following program counts the number of times the letter `a` appears in a string:

```
word = 'banana'
count = 0
for letter in word:
    if letter == 'a':
        count = count + 1
print count
```

This program demonstrates another pattern of computation called a **counter**. The variable `count` is initialized to `0` and then incremented each time an `a` is found. When the loop exits, `count` contains the result—the total number of `a`'s.

Exercise 6.4 Encapsulate this code in a function named `count`, and generalize it so that it accepts the string and the letter as arguments.

Exercise 6.5 Rewrite this function so that instead of traversing the string, it uses the three-parameter version of `find` from the previous section.

6.8 The in operator

The word `in` is a boolean operator that takes two strings and returns `True` if the first appears as a substring in the second:

```
>>> 'a' in 'banana'
True
>>> 'seed' in 'banana'
False
```

6.9 String comparison

The comparison operators work on strings. To see if two strings are equal:

```
if word == 'banana':
    print 'All right, bananas.'
```

Other comparison operations are useful for putting words in alphabetical order:

```
if word < 'banana':
    print 'Your word,' + word + ', comes before banana.'
elif word > 'banana':
    print 'Your word,' + word + ', comes after banana.'
else:
    print 'All right, bananas.'
```

Python does not handle uppercase and lowercase letters the same way that people do. All the uppercase letters come before all the lowercase letters, so:

```
Your word, Pineapple, comes before banana.
```

A common way to address this problem is to convert strings to a standard format, such as all lowercase, before performing the comparison. Keep that in mind in case you have to defend yourself against a man armed with a Pineapple.

6.10 string methods

Strings are an example of Python **objects**. An object contains both data (the actual string itself) as well as **methods** which are effectively functions which are built into the object and available to any **instance** of the object.

Python has a function called `dir` that lists the methods available for an object. The `type` function shows the type of an object and the `dir` function shows the available methods.

```
>>> stuff = 'Hello world'
>>> type(stuff)
```

```
<type 'str'>
>>> dir(stuff)
['capitalize', 'center', 'count', 'decode', 'encode',
 'endswith', 'expandtabs', 'find', 'format', 'index',
 'isalnum', 'isalpha', 'isdigit', 'islower', 'isspace',
 'istitle', 'isupper', 'join', 'ljust', 'lower', 'lstrip',
 'partition', 'replace', 'rfind', 'rindex', 'rjust',
 'rpartition', 'rsplit', 'rstrip', 'split', 'splitlines',
 'startswith', 'strip', 'swapcase', 'title', 'translate',
 'upper', 'zfill']
>>> help(str.capitalize)
Help on method_descriptor:

capitalize(...)
    S.capitalize() -> string

    Return a copy of the string S with only its first character
    capitalized.
>>>
```

While the `dir` function lists the methods, and you can use `help` to get some simple documentation on a method, a better source of documentation for string methods would be docs.python.org/library/string.html.

Calling a **method** is similar to calling a function—it takes arguments and returns a value—but the syntax is different. We call a method by appending the method name to the variable name using the period as a delimiter.

For example, the method `upper` takes a string and returns a new string with all uppercase letters:

Instead of the function syntax `upper(word)`, it uses the method syntax `word.upper()`.

```
>>> word = 'banana'
>>> new_word = word.upper()
>>> print new_word
BANANA
```

This form of dot notation specifies the name of the method, `upper`, and the name of the string to apply the method to, `word`. The empty parentheses indicate that this method takes no argument.

A method call is called an **invocation**; in this case, we would say that we are invoking `upper` on the `word`.

As it turns out, there is a string method named `find` that is remarkably similar to the function we wrote:

```
>>> word = 'banana'
```

```
>>> index = word.find('a')
>>> print index
1
```

In this example, we invoke `find` on `word` and pass the letter we are looking for as a parameter.

Actually, the `find` method is more general than our function; it can find substrings, not just characters:

```
>>> word.find('na')
2
```

It can take as a second argument the index where it should start:

```
>>> word.find('na', 3)
4
```

One common task is to remove white space (spaces, tabs, or newlines) from the beginning and end of a string using the `strip` method:

```
>>> line = ' Here we go '
>>> line.strip()
'Here we go'
```

Some methods such as **startswith** return boolean values.

```
>>> line = 'Please have a nice day'
>>> line.startswith('Please')
True
>>> line.startswith('p')
False
```

You will note that `startswith` requires case to match so sometimes we take a line and map it all to lowercase before we do any checking using the `lower` method.

```
>>> line = 'Please have a nice day'
>>> line.startswith('p')
False
>>> line.lower()
'please have a nice day'
>>> line.lower().startswith('p')
True
```

In the last example, then method `lower` is called and then we use `startswith` check to see if the resulting lowercase string starts with the letter “p”. As long as we are careful with the order, we can make multiple method calls in a single expression.

Exercise 6.6 There is a string method called `count` that is similar to the function in the previous exercise. Read the documentation of this method at docs.python.org/library/string.html and write an invocation that counts the number of times the letter `a` occurs in `'banana'`.

6.11 Parsing strings

Often, we want to look into a string and find a substring. For example if we were presented a series of lines formatted as follows:

```
From stephen.marquard@uct.ac.za Sat Jan 5 09:14:16 2008
```

And we wanted to pull out only the second half of the address (i.e. `uct.ac.za`) from each line. We can do this by using the `find` method and string slicing.

First, we will find the position of the at-sign in the string. Then we will find the position of the first space *after* the at-sign. And then we will use string slicing to extract the portion of the string which we are looking for.

```
>>> data = 'From stephen.marquard@uct.ac.za Sat Jan 5 09:14:16 2008'
>>> atpos = data.find('@')
>>> print atpos
21
>>> spos = data.find(' ',atpos)
>>> print spos
31
>>> host = data[atpos+1:spos]
>>> print host
uct.ac.za
>>>
```

We use a version of the `find` method which allows us to specify a position in the string where we want `find` to start looking. When we slice, we extract the characters from “one beyond the at-sign through up to *but not including* the space character”.

The documentation for the `find` method is available at docs.python.org/library/string.html.

6.12 Format operator

The **format operator**, `%` allows us to construct strings, replacing parts of the strings with the data stored in variables. When applied to integers, `%` is the modulus operator. But when the first operand is a string, `%` is the format operator.

The first operand is the **format string**, which contains one or more **format sequences**, which specify how the second operand is formatted. The result is a string.

For example, the format sequence `'%d'` means that the second operand should be formatted as an integer (`d` stands for “decimal”):

```
>>> camels = 42
>>> '%d' % camels
'42'
```

The result is the string '42', which is not to be confused with the integer value 42.

A format sequence can appear anywhere in the string, so you can embed a value in a sentence:

```
>>> camels = 42
>>> 'I have spotted %d camels.' % camels
'I have spotted 42 camels.'
```

If there is more than one format sequence in the string, the second argument has to be a tuple. Each format sequence is matched with an element of the tuple, in order.

The following example uses '%d' to format an integer, '%g' to format a floating-point number (don't ask why), and '%s' to format a string:

```
>>> 'In %d years I have spotted %g %s.' % (3, 0.1, 'camels')
'In 3 years I have spotted 0.1 camels.'
```

The number of elements in the tuple has to match the number of format sequences in the string. Also, the types of the elements have to match the format sequences:

```
>>> '%d %d %d' % (1, 2)
TypeError: not enough arguments for format string
>>> '%d' % 'dollars'
TypeError: illegal argument type for built-in operation
```

In the first example, there aren't enough elements; in the second, the element is the wrong type.

The format operator is powerful, but it can be difficult to use. You can read more about it at docs.python.org/lib/typesseq-strings.html.

6.13 Debugging

A skill that you should cultivate as you program is always asking yourself, "What could go wrong here?" or alternatively, "What crazy thing might our user do to crash our (seemingly) perfect program?"

For example, look at the program which we used to demonstrate the while loop in the chapter on iteration:

```
while True:
    line = raw_input('> ')
    if line[0] == '#':
        continue
    if line == 'done':
        break
    print line

print 'Done!'
```

Look what happens when the user enters an empty line of input:

```
> hello there
hello there
> # don't print this
> print this!
print this!
>
Traceback (most recent call last):
  File "copytildone.py", line 3, in <module>
    if line[0] == '#' :
```

The code works fine until it is presented an empty line. Then there is no zeroth character so we get a traceback. There are two solutions to this to make line three “safe” even if the line is empty.

One possibility is to simply use the `startswith` method which returns `False` if the string is empty.

```
if line.startswith('#') :
```

Another way to safely write the `if` statement using the **guardian** pattern and make sure the second logical expression is evaluated only where there is at least one character in the string.:

```
if len(line) > 0 and line[0] == '#' :
```

Another common source of problems is when you hand-construct index values to move through a sequence. It can be quite tricky to get the beginning and end of the traversal right.

Here is a function that is supposed to compare two words and return `True` if one of the words is the reverse of the other, but it contains two errors:

```
def is_reverse(word1, word2):
    if len(word1) != len(word2):
        return False

    i = 0
    j = len(word2)

    while j > 0:
        if word1[i] != word2[j]:
            return False
        i = i+1
        j = j-1

    return True
```

The first `if` statement checks whether the words are the same length. If not, we can return `False` immediately and then, for the rest of the function, we can assume that the words are the same length. This is another example of the guardian pattern.

`i` and `j` are indices: `i` traverses `word1` forward while `j` traverses `word2` backward. If we find two letters that don't match, we can return `False` immediately. If we get through the whole loop and all the letters match, we return `True`.

If we test this function with the words "pots" and "stop", we expect the return value `True`, but we get an `IndexError`:

```
>>> is_reverse('pots', 'stop')
...
File "reverse.py", line 15, in is_reverse
    if word1[i] != word2[j]:
IndexError: string index out of range
```

For debugging this kind of error, my first move is to print the values of the indices immediately before the line where the error appears.

```
while j > 0:
    print i, j      # print here

    if word1[i] != word2[j]:
        return False
    i = i+1
    j = j-1
```

Now when I run the program again, I get more information:

```
>>> is_reverse('pots', 'stop')
0 4
...
IndexError: string index out of range
```

The first time through the loop, the value of `j` is 4, which is out of range for the string 'pots'. The index of the last character is 3, so the initial value for `j` should be `len(word2)-1`.

If I fix that error and run the program again, I get:

```
>>> is_reverse('pots', 'stop')
0 3
1 2
2 1
True
```

This time we get the right answer, but it looks like the loop only ran three times, which is suspicious. To get a better idea of what is happening, it is useful to draw a state diagram. During the first iteration, the frame for `is_reverse` looks like this:

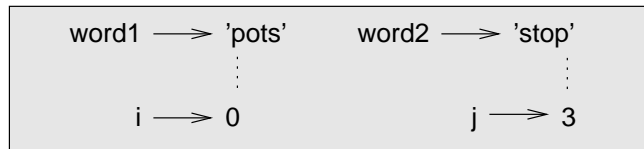

I took a little license by arranging the variables in the frame and adding dotted lines to show that the values of *i* and *j* indicate characters in *word1* and *word2*.

Exercise 6.7 Starting with this diagram, execute the program on paper, changing the values of *i* and *j* during each iteration. Find and fix the second error in this function.

6.14 Glossary

object: Something a variable can refer to. For now, you can use “object” and “value” interchangeably.

sequence: An ordered set; that is, a set of values where each value is identified by an integer index.

item: One of the values in a sequence.

index: An integer value used to select an item in a sequence, such as a character in a string.

slice: A part of a string specified by a range of indices.

empty string: A string with no characters and length 0, represented by two quotation marks.

immutable: The property of a sequence whose items cannot be assigned.

traverse: To iterate through the items in a sequence, performing a similar operation on each.

search: A pattern of traversal that stops when it finds what it is looking for.

counter: A variable used to count something, usually initialized to zero and then incremented.

method: A function that is associated with an object and called using dot notation.

invocation: A statement that calls a method.

format operator: An operator, `%`, that takes a format string and a tuple and generates a string that includes the elements of the tuple formatted as specified by the format string.

format string: A string, used with the format operator, that contains format sequences.

format sequence: A sequence of characters in a format string, like `%d`, that specifies how a value should be formatted.

flag: A boolean variable used to indicate whether a condition is true.

6.15 Exercises

Exercise 6.8 Write some code to parse lines of the form:

```
X-DSPAM-Confidence: 0.8475
```

Use `find` and string slicing to extract the portion of the string after the colon character and then use the `float` function to convert the extracted string into a floating point number.

Exercise 6.9 A string slice can take a third index that specifies the “step size;” that is, the number of spaces between successive characters. A step size of 2 means every other character; 3 means every third, etc.

```
>>> fruit = 'banana'
>>> fruit[0:5:2]
'bnn'
```

A step size of -1 goes through the word backwards, so the slice `[::-1]` generates a reversed string.

Exercise 6.10 Read the documentation of the string methods at docs.python.org/lib/string-methods.html. You might want to experiment with some of them to make sure you understand how they work. `strip` and `replace` are particularly useful.

The documentation uses a syntax that might be confusing. For example, in `find(sub[, start[, end]])`, the brackets indicate optional arguments. So `sub` is required, but `start` is optional, and if you include `start`, then `end` is optional.

Exercise 6.11 The following functions are all *intended* to check whether a string contains any lowercase letters, but at least some of them are wrong. For each function, describe what the function actually does (assuming that the parameter is a string).

```
def any_lowercase1(s):
    for c in s:
        if c.islower():
            return True
        else:
            return False

def any_lowercase2(s):
    for c in s:
        if 'c'.islower():
            return 'True'
        else:
            return 'False'

def any_lowercase3(s):
    for c in s:
        flag = c.islower()
```

```
        return flag

def any_lowercase4(s):
    flag = False
    for c in s:
        flag = flag or c.islower()
    return flag

def any_lowercase5(s):
    for c in s:
        if not c.islower():
            return False
    return True
```

Exercise 6.12 ROT13 is a weak form of encryption that involves “rotating” each letter in a word by 13 places¹. To rotate a letter means to shift it through the alphabet, wrapping around to the beginning if necessary, so 'A' shifted by 3 is 'D' and 'Z' shifted by 1 is 'A'.

Write a function called `rotate_word` that takes a string and an integer as parameters and returns a new string that contains the letters from the original string “rotated” by the given amount.

For example, “cheer” rotated by 7 is “jolly” and “melon” rotated by -10 is “cubed”.

You might want to use the built-in functions `ord`, which converts a character to a numeric code, and `chr`, which converts numeric codes to characters.

Potentially offensive jokes on the Internet are sometimes encoded in ROT13. If you are not easily offended, find and decode some of them.

¹See wikipedia.org/wiki/ROT13

Chapter 7

Files

7.1 Persistence

So far, we have learned how to write programs and communicate our intentions to the **Central Processing Unit** using conditional execution, functions, and iterations. We have learned how to create and use data structures in the **Main Memory**. The CPU and memory are where our software works and runs. It is where all of the “thinking” happens.

But if you recall from our hardware architecture discussions, once the power is turned off, anything stored in either the CPU or main memory is erased. So up to now, our programs have just been transient fun exercises to learn Python.

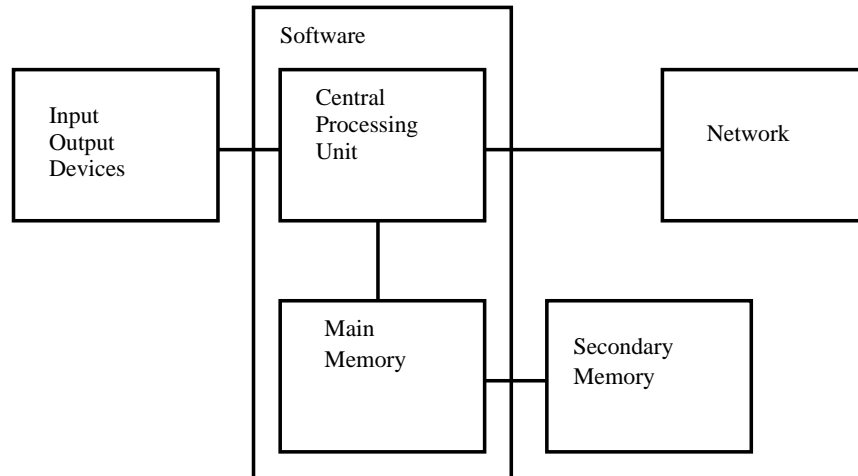

In this chapter, we start to work with **Secondary Memory** (or files). Secondary memory not erased even when the power is turned off. Or in the case of a USB flash drive, the data can we write from our programs can be removed from the system and transported to another system.

We will primarily focus on reading and writing text files such as those we create in a text editor. Later we will see how to work with database files which are binary files, specifically designed to be read and written through database software.

7.2 Opening files

When we want to read or write a file (say on your hard drive), we first must **open** the file. Opening the file communicates with your operating system which knows where the data for each file is stored. When you open a file, you are asking the operating system to find the file by name and make sure the file exists. In this example, we open the file `mbox.txt` which should be stored in the same folder that you in when you start Python. You can download this file from www.py4inf.com/code/mbox.txt

```
>>> fhand = open('mbox.txt')
>>> print fhand
<open file 'mbox.txt', mode 'r' at 0x1005088b0>
```

If the open is successful, the operating system returns us a **file handle**. The file handle is not the actual data contained in the file, but instead it is a “handle” that we can use to read the data. You are given a handle if the requested file exists and you have the proper permissions to read the file.

If the file does not exist, open will fail with a traceback and you will not get a handle to access the contents of the file:

```
>>> fhand = open('stuff.txt')
Traceback (most recent call last):
  File "<stdin>", line 1, in <module>
IOError: [Errno 2] No such file or directory: 'stuff.txt'
```

Later we will use `try` and `except` to deal more gracefully with the situation where we attempt to open a file that does not exist.

7.3 Text files and lines

A text file can be thought of as a sequence of lines, much like a Python string can be through of as a sequence of characters. For example, this is a sample of a text file which records mail activity from various individuals in an open source project development team:

```
From stephen.marquard@uct.ac.za Sat Jan 5 09:14:16 2008
Return-Path: <postmaster@collab.sakaiproject.org>
Date: Sat, 5 Jan 2008 09:12:18 -0500
To: source@collab.sakaiproject.org
From: stephen.marquard@uct.ac.za
Subject: [sakai] svn commit: r39772 - content/branches/
```

Details: <http://source.sakaiproject.org/viewsvn/?view=rev&rev=39772>
...

The entire file is mail interactions is available from www.py4inf.com/code/mbox.txt and a shortened version of the file is available from www.py4inf.com/code/mbox-short.txt. These files are in a standard format for a file containing multiple mail messages. The lines which start with “From ” separate the messages and the lines which start with “From:” are part of the messages. For more information, see en.wikipedia.org/wiki/Mbox.

To break the file into lines, there is a special character that represents the “end of the line” called the **newline** character.

In Python, we represent the **newline** character as a backslash-n in string constants. Even though this looks like two characters, it is actually a single character. When we look at the variable by entering “stuff” in the interpreter, it shows us the `\n` in the string, but when we use `print` to show the string, we see the string broken into two lines by the newline character.

```
>>> stuff = 'Hello\nWorld!'
>>> stuff
'Hello\nWorld!'
>>> print stuff
Hello
World!
>>> stuff = 'X\nY'
>>> print stuff
X
Y
>>> len(stuff)
3
```

You can also see that the length of the string `'X\nY'` is *three* characters because the newline character is a single character.

So when we look at the lines in a file, we need to *imagine* that there is a special invisible character at the end of each line that marks the end of the line called the newline.

```
From stephen.marquard@uct.ac.za Sat Jan 5 09:14:16 2008\n
Return-Path: <postmaster@collab.sakaiproject.org>\n
Date: Sat, 5 Jan 2008 09:12:18 -0500\n
To: source@collab.sakaiproject.org\n
From: stephen.marquard@uct.ac.za\n
Subject: [sakai] svn commit: r39772 - content/branches/\n
Details: http://source.sakaiproject.org/viewsvn/?view=rev&rev=39772\n
...
```

So the newline character separates the characters in the file into lines.

7.4 Reading files

While the **file handle** does not contain the data for the file, it is quite easy to construct a for loop to read through and count each of the lines in a file:

```
fhand = open('mbox.txt')
count = 0
for line in fhand:
    count = count + 1
print 'Line Count:', count
```

```
python open.py
Line Count: 132045
```

We can use the file handle as the sequence in our for loop. Our for loop simply counts the number of lines in the file and prints them out. The rough translation of the for loop into English is, “for each line in the file represented by the file handle, add one to the count variable.”

The reason that the open function does not read the entire file is that the file might be quite large with many gigabytes of data. The open statement takes the same amount of time regardless of the size of the file. The for loop actually causes the data to be read from the file.

When the file is read using a for loop in this manner, Python takes care of splitting the data in the file into separate lines using the newline character. Python reads each line through the newline and includes the newline as the last character in the line variable for each iteration of the for loop.

Because the for loop reads the data one line at a time, it can efficiently read and count the lines in very large files without running out of main memory to store the data. The above program can count the lines in any sized file using very little memory since each line is read, counted, and then discarded.

If you know the file is relatively small compared to the size of your main memory, you can read the whole file into one string using the read method on the file handle.

```
>>> fhand = open('mbox-short.txt')
>>> inp = fhand.read()
>>> print len(inp)
94626
>>> print inp[:20]
From stephen.marquar
```

In this example, the entire contents (all 94,626 characters) of the file `mbox-short.txt` are read directly into the variable `inp`. We use string slicing to print out the first 20 characters of the string data stored in `inp`.

When the file is read in this manner, all the characters including all of the lines and newline characters are one big string in the variable **inp**. Remember that this form of the open

function should only be used if the file data will fit comfortably in the main memory of your computer.

If the file is too large to fit in main memory, you should write your program to read the file in chunks using a `for` or `while` loop.

7.5 Searching through a file

When you are searching through data in a file, it is a very common pattern to read through a file, ignoring most of the lines and only processing lines which meet a particular criteria. We can combine the pattern for reading a file with string **methods** to build simple search mechanisms.

For example, if we wanted to read a file and only print out lines which started with the prefix “From:”, we could use the string method **startswith** to select only those lines with the desired prefix:

```
fhand = open('mbox-short.txt')
for line in fhand:
    if line.startswith('From:') :
        print line
```

When this program runs, we get the following output:

```
From: stephen.marquard@uct.ac.za

From: louis@media.berkeley.edu

From: zqian@umich.edu

From: rjlowe@iupui.edu
...
```

The output looks great since the only lines we are seeing are those which start with “From:”, but why are we seeing the extra blank lines? This is due to that invisible **newline** character. Each of the lines ends with a newline, so the `print` statement prints the string in the variable **line** which includes a newline and then `print` adds *another* newline, resulting in the double spacing effect we see.

We could use line slicing to print all but the last character, but a simpler approach is to use the **rstrip** method which strips whitespace from the right side of a string as follows:

```
fhand = open('mbox-short.txt')
for line in fhand:
    line = line.rstrip()
    if line.startswith('From:') :
        print line
```

When this program runs, we get the following output:

```
From: stephen.marquard@uct.ac.za
From: louis@media.berkeley.edu
From: zqian@umich.edu
From: rjlowe@iupui.edu
From: zqian@umich.edu
From: rjlowe@iupui.edu
From: cwen@iupui.edu
...
```

As your file processing programs get more complicated, you may want to structure your search loops using `continue`. The basic idea of the search loop is that you are looking for “interesting” lines and effectively skipping “uninteresting” lines. And then when we find an interesting line, we do something with that line.

We can structure the loop to follow the pattern of skipping uninteresting lines as follows:

```
fhand = open('mbox-short.txt')
for line in fhand:
    line = line.rstrip()
    # Skip 'uninteresting lines'
    if not line.startswith('From:') :
        continue
    # Process our 'interesting' line
    print line
```

The output of the program is the same. In English, the uninteresting lines are those which do not start with “From:”, which we skip using `continue`. For the “interesting” lines (i.e. those that start with “From:”) we perform the processing on those lines.

We can use the `find` string method to simulate a text editor search which finds lines where the search string is anywhere in the line. Since `find` looks for an occurrence of a string within another string and either returns the position of the string or `-1` if the string was not found, we can write the following loop to show lines which contain the string “@uct.ac.za” (i.e. they come from the University of Capetown in South Africa):

```
fhand = open('mbox-short.txt')
for line in fhand:
    line = line.rstrip()
    if line.find('@uct.ac.za') == -1 :
        continue
    print line
```

Which produces the following output:

```
From stephen.marquard@uct.ac.za Sat Jan 5 09:14:16 2008
X-Authentication-Warning: set sender to stephen.marquard@uct.ac.za using -f
From: stephen.marquard@uct.ac.za
```

```
Author: stephen.marquard@uct.ac.za
From: david.horwitz@uct.ac.za Fri Jan 4 07:02:32 2008
X-Authentication-Warning: set sender to david.horwitz@uct.ac.za using -f
From: david.horwitz@uct.ac.za
Author: david.horwitz@uct.ac.za
...
```

7.6 Letting the user choose the file name

We really do not want to have to edit our Python code every time we want to process a different file. It would be more usable to ask the user to enter the file name string each time the program runs so they can use our program on different files without changing the Python code.

This is quite simple to do by reading the file name from the user using `raw_input` as follows:

```
fname = raw_input('Enter the file name: ')
fhand = open(fname)
count = 0
for line in fhand:
    if line.startswith('Subject:') :
        count = count + 1
print 'There were', count, 'subject lines in', fname
```

We read the file name from the user and place it in a variable named `fname` and open that file. Now we can run the program repeatedly on different files.

```
python search6.py
Enter the file name: mbox.txt
There were 1797 subject lines in mbox.txt
```

```
python search6.py
Enter the file name: mbox-short.txt
There were 27 subject lines in mbox-short.txt
```

Before peeking at the next section, take a look at the above program and ask yourself, “What could go possibly wrong here?” or “What might our friendly user do that would cause our nice little program to ungracefully exit with a traceback, making us look not-so-cool in the eyes of our users?”.

7.7 Using `try`, `catch`, and `open`

I told you not to peek. This is your last chance.

What if our user types something that is not a file name?

```
python search6.py
Enter the file name: missing.txt
Traceback (most recent call last):
  File "search6.py", line 2, in <module>
    fhand = open(fname)
IOError: [Errno 2] No such file or directory: 'missing.txt'
```

```
python search6.py
Enter the file name: na na boo boo
Traceback (most recent call last):
  File "search6.py", line 2, in <module>
    fhand = open(fname)
IOError: [Errno 2] No such file or directory: 'na na boo boo'
```

Do not laugh, users will eventually do every possible thing they can do to break your programs — either on purpose or with malicious intent. As a matter of fact, an important part of any software development team is a person or group called **Quality Assurance** (or QA for short) whose very job it is to do the craziest things possible in an attempt to break the software that the programmer has created.

The QA team is responsible for finding the flaws in programs before we have delivered the program to the end-users who may be purchasing the software or paying our salary to write the software. So the QA team is the programmer's best friend.

So now that we see the flaw in the program, we can elegantly fix it using the `try/except` structure. We need to assume that the `open` call might fail and add recovery code when the `open` fails as follows:

```
fname = raw_input('Enter the file name: ')
try:
    fhand = open(fname)
except:
    print 'File cannot be opened:', fname
    exit()

count = 0
for line in fhand:
    if line.startswith('Subject:') :
        count = count + 1
print 'There were', count, 'subject lines in', fname
```

The `exit` function terminates the program. It is a function that we call that never returns. Now when our user (or QA team) types in silliness or bad file names, we “catch” them and recover gracefully:

```
python search7.py
Enter the file name: mbox.txt
There were 1797 subject lines in mbox.txt
```

```
python search7.py
Enter the file name: na na boo boo
File cannot be opened: na na boo boo
```

Protecting the open call is a good example of the proper use of `try` and `except` in a Python program. We use the term “Pythonic” when we are doing something the “Python way”. We might say that the above example is the Pythonic way to open a file.

Once you become more skilled in Python, you can engage in *reparte* with other Python programmers to decide which of two equivalent solutions to a problem is “more Pythonic”. The goal to be “more Pythonic” captures the notion that programming is part engineering and part art. We are not always interested in just making something work, we also want our solution to be elegant.

7.8 Writing files

To write a file, you have to open it with mode `'w'` as a second parameter:

```
>>> fout = open('output.txt', 'w')
>>> print fout
<open file 'output.txt', mode 'w' at 0xb7eb2410>
```

If the file already exists, opening it in write mode clears out the old data and starts fresh, so be careful! If the file doesn't exist, a new one is created.

The write method of the file handle object puts data into the file.

```
>>> line1 = 'This here's the wattle,\n'
>>> fout.write(line1)
```

Again, the file object keeps track of where it is, so if you call `write` again, it adds the new data to the end.

We must make sure to manage the ends of lines as we write to the file by explicitly inserting the newline character when we want to end a line. The `print` statement automatically appends a newline, but the `write` method does not add the newline automatically.

```
>>> line2 = 'the emblem of our land.\n'
>>> fout.write(line2)
```

When you are done writing, you have to close the file to make sure that the last bit of data is physically written to the disk so it will not be lost if the power goes off.

```
>>> fout.close()
```

We could close the files which we open for read as well, but we can be a little sloppy if we are only opening a few files since Python makes sure that all open files are closed when the program ends. When we are writing files, we want to explicitly close the files so as to leave nothing to chance.

7.9 Debugging

When you are reading and writing files, you might run into problems with whitespace. These errors can be hard to debug because spaces, tabs and newlines are normally invisible:

```
>>> s = '1 2\t 3\n 4'
>>> print s
1 2 3
 4
```

The built-in function `repr` can help. It takes any object as an argument and returns a string representation of the object. For strings, it represents whitespace characters with backslash sequences:

```
>>> print repr(s)
'1 2\t 3\n 4'
```

This can be helpful for debugging.

One other problem you might run into is that different systems use different characters to indicate the end of a line. Some systems use a newline, represented `\n`. Others use a return character, represented `\r`. Some use both. If you move files between different systems, these inconsistencies might cause problems.

For most systems, there are applications to convert from one format to another. You can find them (and read more about this issue) at wikipedia.org/wiki/Newline. Or, of course, you could write one yourself.

7.10 Glossary

text file: A sequence of characters stored in permanent storage like a hard drive.

newline: A special character used in files and strings to indicate the end of a line.

catch: To prevent an exception from terminating a program using the `try` and `except` statements.

Quality Assurance: A person or team focused on insuring the overall quality of a software product. QA is often involved in testing a product and identifying problems before the product is released.

Pythonic: A technique that works elegantly in Python. “Using `try` and `except` is the *Pythonic* way to recover from missing files.”.

7.11 Exercises

Exercise 7.1 Write a program to read through a file and print the contents of the file (line by line) all in upper case. Executing the program will look as follows:

```
python shout.py
Enter a file name: mbox-short.txt
FROM STEPHEN.MARQUARD@UCT.AC.ZA SAT JAN  5 09:14:16 2008
RETURN-PATH: <POSTMASTER@COLLAB.SAKAIPROJECT.ORG>
RECEIVED: FROM MURDER (MAIL.UMICH.EDU [141.211.14.90])
  BY FRANKENSTEIN.MAIL.UMICH.EDU (CYRUS V2.3.8) WITH LMTPA;
  SAT, 05 JAN 2008 09:14:16 -0500
```

You can download the file from www.py4inf.com/code/mbox-short.txt

Exercise 7.2 Write a program to loop through a mailbox-format file and look for lines of the form:

```
X-DSPAM-Confidence: 0.8475
```

When you encounter a line that starts with “X-DSPAM-Confidence:” pull apart the line to extract the floating point number on the line. Count these lines and compute the total of the spam confidence values from these lines. When you reach the end of the file, print out the average spam confidence.

```
Enter the file name: mbox.txt
Average spam confidence: 0.894128046745
```

```
Enter the file name: mbox-short.txt
Average spam confidence: 0.750718518519
```

Exercise 7.3 Sometimes when programmers get bored or want to have a bit of fun, they add a harmless **Easter Egg** to their program ([en.wikipedia.org/wiki/Easter_egg_\(media\)](http://en.wikipedia.org/wiki/Easter_egg_(media))). Modify the program that prompts the user for the file name so that it prints a funny message when the user types in the exact file name ‘na na boo boo’. The program should behave normally for all other files which exist and don’t exist. Here is a sample execution of the program:

```
python egg.py
Enter the file name: mbox.txt
There were 1797 subject lines in mbox.txt
```

```
python egg.py
Enter the file name: missing.tyxt
File cannot be opened: missing.tyxt
```

```
python egg.py
Enter the file name: na na boo boo
NA NA BOO BOO TO YOU - You have been punk'd!
```

We are not encouraging you to put Easter Eggs in your programs - this is just an exercise.

Chapter 8

Lists

8.1 A list is a sequence

Like a string, a **list** is a sequence of values. In a string, the values are characters; in a list, they can be any type. The values in list are called **elements** or sometimes **items**.

There are several ways to create a new list; the simplest is to enclose the elements in square brackets ([and]):

```
[10, 20, 30, 40]
['crunchy frog', 'ram bladder', 'lark vomit']
```

The first example is a list of four integers. The second is a list of three strings. The elements of a list don't have to be the same type. The following list contains a string, a float, an integer, and (lo!) another list:

```
['spam', 2.0, 5, [10, 20]]
```

A list within another list is **nested**.

A list that contains no elements is called an empty list; you can create one with empty brackets, [].

As you might expect, you can assign list values to variables:

```
>>> cheeses = ['Cheddar', 'Edam', 'Gouda']
>>> numbers = [17, 123]
>>> empty = []
>>> print cheeses, numbers, empty
['Cheddar', 'Edam', 'Gouda'] [17, 123] []
```

8.2 Lists are mutable

The syntax for accessing the elements of a list is the same as for accessing the characters of a string—the bracket operator. The expression inside the brackets specifies the index. Remember that the indices start at 0:

```
>>> print cheeses[0]
Cheddar
```

Unlike strings, lists are mutable. When the bracket operator appears on the left side of an assignment, it identifies the element of the list that will be assigned.

```
>>> numbers = [17, 123]
>>> numbers[1] = 5
>>> print numbers
[17, 5]
```

The one-eth element of `numbers`, which used to be 123, is now 5.

You can think of a list as a relationship between indices and elements. This relationship is called a **mapping**; each index “maps to” one of the elements. Here is a state diagram showing `cheeses`, `numbers` and `empty`:

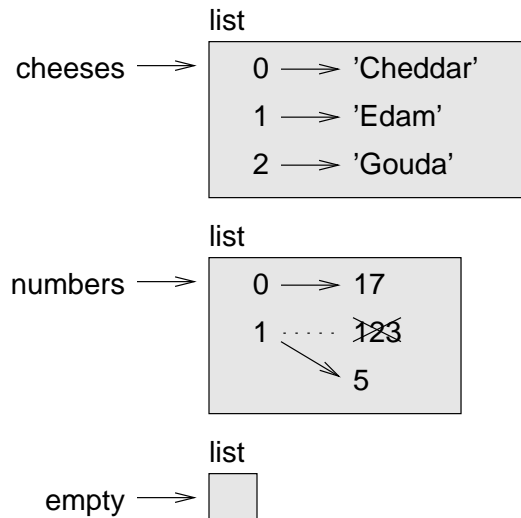

Lists are represented by boxes with the word “list” outside and the elements of the list inside. `cheeses` refers to a list with three elements indexed 0, 1 and 2. `numbers` contains two elements; the diagram shows that the value of the second element has been reassigned from 123 to 5. `empty` refers to a list with no elements.

List indices work the same way as string indices:

- Any integer expression can be used as an index.

- If you try to read or write an element that does not exist, you get an `IndexError`.
- If an index has a negative value, it counts backward from the end of the list.

The `in` operator also works on lists.

```
>>> cheeses = ['Cheddar', 'Edam', 'Gouda']
>>> 'Edam' in cheeses
True
>>> 'Brie' in cheeses
False
```

8.3 Traversing a list

The most common way to traverse the elements of a list is with a `for` loop. The syntax is the same as for strings:

```
for cheese in cheeses:
    print cheese
```

This works well if you only need to read the elements of the list. But if you want to write or update the elements, you need the indices. A common way to do that is to combine the functions `range` and `len`:

```
for i in range(len(numbers)):
    numbers[i] = numbers[i] * 2
```

This loop traverses the list and updates each element. `len` returns the number of elements in the list. `range` returns a list of indices from 0 to $n - 1$, where n is the length of the list. Each time through the loop `i` gets the index of the next element. The assignment statement in the body uses `i` to read the old value of the element and to assign the new value.

A `for` loop over an empty list never executes the body:

```
for x in empty:
    print 'This never happens.'
```

Although a list can contain another list, the nested list still counts as a single element. The length of this list is four:

```
['spam', 1, ['Brie', 'Roquefort', 'Pol le Veq'], [1, 2, 3]]
```

8.4 List operations

The `+` operator concatenates lists:

```
>>> a = [1, 2, 3]
>>> b = [4, 5, 6]
>>> c = a + b
>>> print c
[1, 2, 3, 4, 5, 6]
```

Similarly, the `*` operator repeats a list a given number of times:

```
>>> [0] * 4
[0, 0, 0, 0]
>>> [1, 2, 3] * 3
[1, 2, 3, 1, 2, 3, 1, 2, 3]
```

The first example repeats `[0]` four times. The second example repeats the list `[1, 2, 3]` three times.

8.5 List slices

The slice operator also works on lists:

```
>>> t = ['a', 'b', 'c', 'd', 'e', 'f']
>>> t[1:3]
['b', 'c']
>>> t[:4]
['a', 'b', 'c', 'd']
>>> t[3:]
['d', 'e', 'f']
```

If you omit the first index, the slice starts at the beginning. If you omit the second, the slice goes to the end. So if you omit both, the slice is a copy of the whole list.

```
>>> t[:]
['a', 'b', 'c', 'd', 'e', 'f']
```

Since lists are mutable, it is often useful to make a copy before performing operations that fold, spindle or mutilate lists.

A slice operator on the left side of an assignment can update multiple elements:

```
>>> t = ['a', 'b', 'c', 'd', 'e', 'f']
>>> t[1:3] = ['x', 'y']
>>> print t
['a', 'x', 'y', 'd', 'e', 'f']
```

8.6 List methods

Python provides methods that operate on lists. For example, `append` adds a new element to the end of a list:

```
>>> t = ['a', 'b', 'c']
>>> t.append('d')
>>> print t
['a', 'b', 'c', 'd']
```

extend takes a list as an argument and appends all of the elements:

```
>>> t1 = ['a', 'b', 'c']
>>> t2 = ['d', 'e']
>>> t1.extend(t2)
>>> print t1
['a', 'b', 'c', 'd', 'e']
```

This example leaves t2 unmodified.

sort arranges the elements of the list from low to high:

```
>>> t = ['d', 'c', 'e', 'b', 'a']
>>> t.sort()
>>> print t
['a', 'b', 'c', 'd', 'e']
```

Most list methods are void; they modify the list and return None. If you accidentally write `t = t.sort()`, you will be disappointed with the result.

8.7 Deleting elements

There are several ways to delete elements from a list. If you know the index of the element you want, you can use `pop`:

```
>>> t = ['a', 'b', 'c']
>>> x = t.pop(1)
>>> print t
['a', 'c']
>>> print x
b
```

`pop` modifies the list and returns the element that was removed. If you don't provide an index, it deletes and returns the last element.

If you don't need the removed value, you can use the `del` operator:

```
>>> t = ['a', 'b', 'c']
>>> del t[1]
>>> print t
['a', 'c']
```

If you know the element you want to remove (but not the index), you can use `remove`:

```
>>> t = ['a', 'b', 'c']
>>> t.remove('b')
>>> print t
['a', 'c']
```

The return value from `remove` is `None`.

To remove more than one element, you can use `del` with a slice index:

```
>>> t = ['a', 'b', 'c', 'd', 'e', 'f']
>>> del t[1:5]
>>> print t
['a', 'f']
```

As usual, the slice selects all the elements up to, but not including, the second index.

8.8 Lists and strings

A string is a sequence of characters and a list is a sequence of values, but a list of characters is not the same as a string. To convert from a string to a list of characters, you can use `list`:

```
>>> s = 'spam'
>>> t = list(s)
>>> print t
['s', 'p', 'a', 'm']
```

Because `list` is the name of a built-in function, you should avoid using it as a variable name. I also avoid `l` because it looks too much like `1`. So that's why I use `t`.

The `list` function breaks a string into individual letters. If you want to break a string into words, you can use the `split` method:

```
>>> s = 'pining for the fjords'
>>> t = s.split()
>>> print t
['pining', 'for', 'the', 'fjords']
>>> print t[2]
the
```

Once you have used `split` to break the string into a list of tokens, you can use the index operator (square bracket) to look at a particular word in the list.

You can call `split` with an optional argument called a **delimiter** specifies which characters to use as word boundaries. The following example uses a hyphen as a delimiter:

```
>>> s = 'spam-spam-spam'
>>> delimiter = '-'
>>> s.split(delimiter)
['spam', 'spam', 'spam']
```

`join` is the inverse of `split`. It takes a list of strings and concatenates the elements. `join` is a string method, so you have to invoke it on the delimiter and pass the list as a parameter:

```
>>> t = ['pining', 'for', 'the', 'fjords']
>>> delimiter = ' '
>>> delimiter.join(t)
'pining for the fjords'
```

In this case the delimiter is a space character, so `join` puts a space between words. To concatenate strings without spaces, you can use the empty string, `' '`, as a delimiter.

8.9 Parsing lines

Usually when we are reading a file we want to do something to the lines other than just printing the whole line. Often we want to find the “interesting lines” and then **parse** the line to find some interesting *part* of the line. What if we wanted to print out the day of the week from those lines that start with “From”.

```
From stephen.marquard@uct.ac.za Sat Jan 5 09:14:16 2008
```

The `split` method is very effective when faced with this kind of problem. We can write a small program that looks for lines where the line starts with “From” and then `split` those lines and then print out the third word in the line:

```
fhand = open('mbox-short.txt')
for line in fhand:
    line = line.rstrip()
    if not line.startswith('From ') : continue
    words = line.split()
    print words[2]
```

We also use the contracted form of the `if` statement where we put the `continue` on the same line as the `if`. This contracted form of the `if` functions the same as if the `continue` were on the next line and indented.

The program produces the following output:

```
Sat
Fri
Fri
Fri
...
```

Later, we will learn increasingly sophisticated techniques for picking the lines to work on and how we pull those lines apart to find the exact bit of information we are looking for.

8.10 Objects and values

If we execute these assignment statements:

```
a = 'banana'
b = 'banana'
```

We know that `a` and `b` both refer to a string, but we don't know whether they refer to the *same* string. There are two possible states:

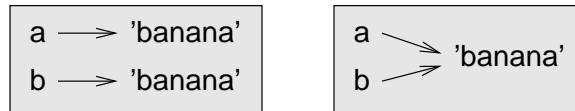

In one case, `a` and `b` refer to two different objects that have the same value. In the second case, they refer to the same object.

To check whether two variables refer to the same object, you can use the `is` operator.

```
>>> a = 'banana'
>>> b = 'banana'
>>> a is b
True
```

In this example, Python only created one string object, and both `a` and `b` refer to it.

But when you create two lists, you get two objects:

```
>>> a = [1, 2, 3]
>>> b = [1, 2, 3]
>>> a is b
False
```

So the state diagram looks like this:

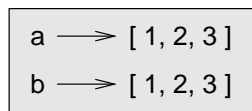

In this case we would say that the two lists are **equivalent**, because they have the same elements, but not **identical**, because they are not the same object. If two objects are identical, they are also equivalent, but if they are equivalent, they are not necessarily identical.

Until now, we have been using “object” and “value” interchangeably, but it is more precise to say that an object has a value. If you execute `a = [1, 2, 3]`, `a` refers to a list object whose value is a particular sequence of elements. If another list has the same elements, we would say it has the same value.

8.11 Aliasing

If `a` refers to an object and you assign `b = a`, then both variables refer to the same object:

```
>>> a = [1, 2, 3]
>>> b = a
>>> b is a
True
```

The state diagram looks like this:

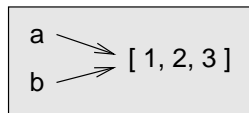

The association of a variable with an object is called a **reference**. In this example, there are two references to the same object.

An object with more than one reference has more than one name, so we say that the object is **aliased**.

If the aliased object is mutable, changes made with one alias affect the other:

```
>>> b[0] = 17
>>> print a
[17, 2, 3]
```

Although this behavior can be useful, it is error-prone. In general, it is safer to avoid aliasing when you are working with mutable objects.

For immutable objects like strings, aliasing is not as much of a problem. In this example:

```
a = 'banana'
b = 'banana'
```

It almost never makes a difference whether `a` and `b` refer to the same string or not.

8.12 List arguments

When you pass a list to a function, the function gets a reference to the list. If the function modifies a list parameter, the caller sees the change. For example, `delete_head` removes the first element from a list:

```
def delete_head(t):
    del t[0]
```

Here's how it is used:

```
>>> letters = ['a', 'b', 'c']
>>> delete_head(letters)
>>> print letters
['b', 'c']
```

The parameter `t` and the variable `letters` are aliases for the same object. The stack diagram looks like this:

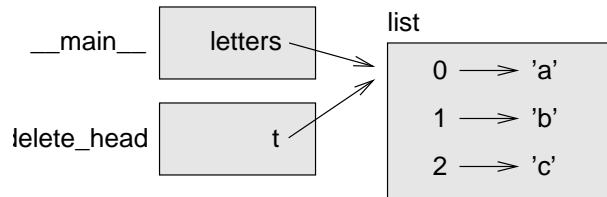

Since the list is shared by two frames, I drew it between them.

It is important to distinguish between operations that modify lists and operations that create new lists. For example, the `append` method modifies a list, but the `+` operator creates a new list:

```
>>> t1 = [1, 2]
>>> t2 = t1.append(3)
>>> print t1
[1, 2, 3]
>>> print t2
None
```

```
>>> t3 = t1 + [3]
>>> print t3
[1, 2, 3]
>>> t2 is t3
False
```

This difference is important when you write functions that are supposed to modify lists. For example, this function *does not* delete the head of a list:

```
def bad_delete_head(t):
    t = t[1:]          # WRONG!
```

The slice operator creates a new list and the assignment makes `t` refer to it, but none of that has any effect on the list that was passed as an argument.

An alternative is to write a function that creates and returns a new list. For example, `tail` returns all but the first element of a list:

```
def tail(t):
    return t[1:]
```

This function leaves the original list unmodified. Here's how it is used:

```
>>> letters = ['a', 'b', 'c']
>>> rest = tail(letters)
>>> print rest
['b', 'c']
```

Exercise 8.1 Write a function called `chop` that takes a list and modifies it, removing the first and last elements, and returns `None`.

Then write a function called `middle` that takes a list and returns a new list that contains all but the first and last elements.

8.13 Debugging

Careless use of lists (and other mutable objects) can lead to long hours of debugging. Here are some common pitfalls and ways to avoid them:

1. Don't forget that most list methods modify the argument and return `None`. This is the opposite of the string methods, which return a new string and leave the original alone.

If you are used to writing string code like this:

```
word = word.strip()
```

It is tempting to write list code like this:

```
t = t.sort()          # WRONG!
```

Because `sort` returns `None`, the next operation you perform with `t` is likely to fail.

Before using list methods and operators, you should read the documentation carefully and then test them in interactive mode. The methods and operators that lists share with other sequences (like strings) are documented at docs.python.org/lib/typesseq.html. The methods and operators that only apply to mutable sequences are documented at docs.python.org/lib/typesseq-mutable.html.

2. Pick an idiom and stick with it.

Part of the problem with lists is that there are too many ways to do things. For example, to remove an element from a list, you can use `pop`, `remove`, `del`, or even a slice assignment.

To add an element, you can use the `append` method or the `+` operator. But don't forget that these are right:

```
t.append(x)
t = t + [x]
```

And these are wrong:

```
t.append([x])          # WRONG!
t = t.append(x)       # WRONG!
t + [x]               # WRONG!
t = t + x             # WRONG!
```

Try out each of these examples in interactive mode to make sure you understand what they do. Notice that only the last one causes a runtime error; the other three are legal, but they do the wrong thing.

3. Make copies to avoid aliasing.

If you want to use a method like `sort` that modifies the argument, but you need to keep the original list as well, you can make a copy.

```
orig = t[:]
t.sort()
```

In this example you could also use the built-in function `sorted`, which returns a new, sorted list and leaves the original alone. But in that case you should avoid using `sorted` as a variable name!

4. Lists, split, and files

When we read and parse files, there are many opportunities to encounter input that can crash our program so it is a good idea to revisit the **guardian** pattern when it comes writing programs that read through a file and look for a “needle in the haystack”.

Lets revisit our program that is looking for the day of the week on the from lines of our file.:

```
From stephen.marquard@uct.ac.za Sat Jan 5 09:14:16 2008
```

Since we are breaking this line into words, we could dispense with the use of `startswith` and simply look at the first word of the line to determine if we are interested in the line at all. We can use `continue` to skip lines that don't have “From” as the first word as follows:

```
fhand = open('mbox-short.txt')
for line in fhand:
    words = line.split()
    if words[0] != 'From' : continue
    print words[2]
```

This looks much simpler and we don't even need to do the `rstrip` to remove the newline at the end of the file. But is it better?

```
python search8.py
Sat
Traceback (most recent call last):
  File "search8.py", line 5, in <module>
    if words[0] != 'From' : continue
IndexError: list index out of range
```

It kind of works and we see the day from the first line (Sat) but then the program fails with a traceback error. What went wrong? What messed-up data caused our elegant, clever and very Pythonic program to fail?

You could stare at it for a long time and puzzle through it or ask someone for help, but the quicker and smarter approach is to add a `print` statement. The best place to add the print statement is right before the line where the program failed and print out the data that seems to be causing the failure.

Now this approach may generate a lot of lines of output but at least you will immediately have some clue as to the problem at hand. So we add a print of the variable `words` right before line five. We even add a prefix “Debug:” to the line so we can keep our regular output separate from our debug output.

```
for line in fhand:
    words = line.split()
    print 'Debug:', words
    if words[0] != 'From' : continue
    print words[2]
```

When we run the program, a lot of output scrolls off the screen but at the end, we see our debug output and the traceback so we know what happened just before the traceback.

```
Debug: ['X-DSPAM-Confidence:', '0.8475']
Debug: ['X-DSPAM-Probability:', '0.0000']
Debug: []
Traceback (most recent call last):
  File "search9.py", line 6, in <module>
    if words[0] != 'From' : continue
IndexError: list index out of range
```

Each debug line is printing the list of words which we get when we `split` the line into words. When the program fails the list of words is empty `[]`. If we open the file in a text editor and look at the file, at that point it looks as follows:

```
X-DSPAM-Result: Innocent
X-DSPAM-Processed: Sat Jan 5 09:14:16 2008
X-DSPAM-Confidence: 0.8475
X-DSPAM-Probability: 0.0000
```

Details: <http://source.sakaiproject.org/viewsvn/?view=rev&rev=39772>

The error occurs when our program encounters a blank line! Of course there are “zero words” on a blank line. Why didn’t we think of that when we were writing the code. When the code looks for the first word (`word[0]`) to check to see if it matches “From”, we get an “index out of range” error.

This of course is the perfect place to add some **guardian** code to avoid checking the first word if the first word is not there. There are many ways to protect this code, we will choose to check the number of words we have before we look at the first word:

```
fhand = open('mbox-short.txt')
count = 0
for line in fhand:
    words = line.split()
    # print 'Debug:', words
    if len(words) == 0 : continue
    if words[0] != 'From' : continue
    print words[2]
```

First we commented out the debug print statement instead of removing it in case our modification fails and we need to debug again. Then we added a guardian statement that checks to see if we have zero words, and if so, we use `continue` to skip to the next line in the file.

We can think of the two `continue` statements as helping us refine the set of lines which are “interesting” to us and which we want to process some more. A line which has no words is “uninteresting” to us so we skip to the next line. A line which does not have “From” as its first word is uninteresting to us so we skip it.

The program as modified runs successfully so perhaps it is correct. Our guardian statement does make sure that the `words[0]` will never fail, but perhaps it is not enough. When we are programming, we must always be thinking, “What might go wrong?”.

Exercise 8.2 Figure out which line of the above program is still not properly guarded. See if you can construct a text file which causes the program to fail and then modify the program so that the line is properly guarded and test it to make sure it handles your new text file.

Exercise 8.3 Rewrite the guardian code in the above example without two `if` statements. Instead use a compound logical expression using the `and` logical operator with a single `if` statement.

8.14 Glossary

list: A sequence of values.

element: One of the values in a list (or other sequence), also called items.

index: An integer value that indicates an element in a list.

nested list: A list that is an element of another list.

list traversal: The sequential accessing of each element in a list.

object: Something a variable can refer to. An object has a type and a value.

equivalent: Having the same value.

identical: Being the same object (which implies equivalence).

reference: The association between a variable and its value.

aliasing: A circumstance where two or more variables refer to the same object.

delimiter: A character or string used to indicate where a string should be split.

8.15 Exercises

Exercise 8.4 Download a copy of the file from www.py4inf.com/code/romeo.txt

Write a program to open the file `romeo.txt` and read it line by line. For each line, split the line into a list of words using the `split` function.

For each word, check to see if the word is already in a list. If the word is not in the list, add it to the list.

When the program completes, sort and print the resulting words in alphabetical order.

```
Enter file: romeo.txt
['Arise', 'But', 'It', 'Juliet', 'Who', 'already',
 'and', 'breaks', 'east', 'envious', 'fair', 'grief',
 'is', 'kill', 'light', 'moon', 'pale', 'sick', 'soft',
 'sun', 'the', 'through', 'what', 'window',
 'with', 'yonder']
```

Exercise 8.5 Write a program to read through the mail box data and when you find line that starts with “From”, you will split the line into words using the `split` function. We are interested in who sent the message which is the second word on the From line.

```
From stephen.marquard@uct.ac.za Sat Jan 5 09:14:16 2008
```

You will parse the From line and print out the second word for each From line and then you will also count the number of From (not From:) lines and print out a count at the end.

This is a sample good output with a few lines removed:

```
python fromcount.py
Enter a file name: mbox-short.txt
stephen.marquard@uct.ac.za
louis@media.berkeley.edu
zqian@umich.edu
```

```
[...some output removed...]
```

```
ray@media.berkeley.edu
cwen@iupui.edu
cwen@iupui.edu
cwen@iupui.edu
There were 27 lines in the file with From as the first word
```

Chapter 9

Dictionaries

A **dictionary** is like a list, but more general. In a list, the positions (a.k.a. indices) have to be integers; in a dictionary the indices can be (almost) any type.

You can think of a dictionary as a mapping between a set of indices (which are called **keys**) and a set of values. Each key maps to a value. The association of a key and a value is called a **key-value pair** or sometimes an **item**.

As an example, we'll build a dictionary that maps from English to Spanish words, so the keys and the values are all strings.

The function `dict` creates a new dictionary with no items. Because `dict` is the name of a built-in function, you should avoid using it as a variable name.

```
>>> eng2sp = dict()
>>> print eng2sp
{}
```

The squiggly-brackets, `{}`, represent an empty dictionary. To add items to the dictionary, you can use square brackets:

```
>>> eng2sp['one'] = 'uno'
```

This line creates an item that maps from the key `'one'` to the value `'uno'`. If we print the dictionary again, we see a key-value pair with a colon between the key and value:

```
>>> print eng2sp
{'one': 'uno'}
```

This output format is also an input format. For example, you can create a new dictionary with three items:

```
>>> eng2sp = {'one': 'uno', 'two': 'dos', 'three': 'tres'}
```

But if you print `eng2sp`, you might be surprised:

```
>>> print eng2sp
{'one': 'uno', 'three': 'tres', 'two': 'dos'}
```

The order of the key-value pairs is not the same. In fact, if you type the same example on your computer, you might get a different result. In general, the order of items in a dictionary is unpredictable.

But that's not a problem because the elements of a dictionary are never indexed with integer indices. Instead, you use the keys to look up the corresponding values:

```
>>> print eng2sp['two']
'dos'
```

The key 'two' always maps to the value 'dos' so the order of the items doesn't matter.

If the key isn't in the dictionary, you get an exception:

```
>>> print eng2sp['four']
KeyError: 'four'
```

The `len` function works on dictionaries; it returns the number of key-value pairs:

```
>>> len(eng2sp)
3
```

The `in` operator works on dictionaries; it tells you whether something appears as a *key* in the dictionary (appearing as a value is not good enough).

```
>>> 'one' in eng2sp
True
>>> 'uno' in eng2sp
False
```

To see whether something appears as a value in a dictionary, you can use the method `values`, which returns the values as a list, and then use the `in` operator:

```
>>> vals = eng2sp.values()
>>> 'uno' in vals
True
```

The `in` operator uses different algorithms for lists and dictionaries. For lists, it uses a search algorithm, as in Section 6.6. As the list gets longer, the search time gets longer in direct proportion. For dictionaries, Python uses an algorithm called a **hashtable** that has a remarkable property; the `in` operator takes about the same amount of time no matter how many items there are in a dictionary. I won't explain how that's possible, but you can read more about it at wikipedia.org/wiki/Hash_table.

Exercise 9.1 Write a function that reads the words in `words.txt` and stores them as keys in a dictionary. It doesn't matter what the values are. Then you can use the `in` operator as a fast way to check whether a string is in the dictionary.

9.1 Dictionary as a set of counters

Suppose you are given a string and you want to count how many times each letter appears. There are several ways you could do it:

1. You could create 26 variables, one for each letter of the alphabet. Then you could traverse the string and, for each character, increment the corresponding counter, probably using a chained conditional.
2. You could create a list with 26 elements. Then you could convert each character to a number (using the built-in function `ord`), use the number as an index into the list, and increment the appropriate counter.
3. You could create a dictionary with characters as keys and counters as the corresponding values. The first time you see a character, you would add an item to the dictionary. After that you would increment the value of an existing item.

Each of these options performs the same computation, but each of them implements that computation in a different way.

An **implementation** is a way of performing a computation; some implementations are better than others. For example, an advantage of the dictionary implementation is that we don't have to know ahead of time which letters appear in the string and we only have to make room for the letters that do appear.

Here is what the code might look like:

```
def histogram(s):
    d = dict()
    for c in s:
        if c not in d:
            d[c] = 1
        else:
            d[c] += 1
    return d
```

The name of the function is **histogram**, which is a statistical term for a set of counters (or frequencies). The `+=` operator is an increment operator and in the above example, we add one to the value stored in `d[c]`.

The first line of the function creates an empty dictionary. The `for` loop traverses the string. Each time through the loop, if the character `c` is not in the dictionary, we create a new item with key `c` and the initial value 1 (since we have seen this letter once). If `c` is already in the dictionary we increment `d[c]`.

Here's how it works:

```
>>> h = histogram('brontosaurus')
>>> print h
{'a': 1, 'b': 1, 'o': 2, 'n': 1, 's': 2, 'r': 2, 'u': 2, 't': 1}
```

The histogram indicates that the letters 'a' and 'b' appear once; 'o' appears twice, and so on.

Exercise 9.2 Dictionaries have a method called `get` that takes a key and a default value. If the key appears in the dictionary, `get` returns the corresponding value; otherwise it returns the default value. For example:

```
>>> h = histogram('a')
>>> print h
{'a': 1}
>>> h.get('a', 0)
1
>>> h.get('b', 0)
0
```

Use `get` to write `histogram` more concisely. You should be able to eliminate the `if` statement.

9.2 Dictionaries and files

One of the common uses of a dictionary is to count the occurrence of words in a file with some written text. Lets start with a very simple file of words taken from the text of *Romeo and Juliet* thanks to http://shakespeare.mit.edu/Tragedy/romeoandjuliet/romeo_juliet.2.2.html.

For the first set of examples, we will use a shortened and simplified version of the text with no punctuation. Later we will work with the text of the scene with punctuation included.

```
But soft what light through yonder window breaks
It is the east and Juliet is the sun
Arise fair sun and kill the envious moon
Who is already sick and pale with grief
```

We will write a Python program to read through the lines of the file, break each line into a list of words, and then loop through each of the words in the line, and count each word using a dictionary.

You will see that we have two `for` loops. The outer loop is reading the lines of the file and the inner loop is iterating through each of the words on that particular line. This is an example of a pattern called **nested loops** because one of the loops is the *outer* loop and the other loop is the *inner* loop.

Because the inner loop executes all of its iterations each time the outer loop makes a single iteration, we think of the inner loop as iterating “more quickly” and the outer loop as iterating more slowly.

The combination of the two nested loops ensures that we will count every word on every line of the input file.

```

fname = raw_input('Enter the file name: ')
try:
    fhand = open(fname)
except:
    print 'File cannot be opened:', fname
    exit()

counts = dict()
for line in fhand:
    words = line.split()
    for word in words:
        if word not in counts:
            counts[word] = 1
        else:
            counts[word] += 1

print counts

```

When we run the program, we see a raw dump of all of the counts in unsorted hash order. (the romeo.txt file is available at www.py4inf.com/code/romeo.txt)

```

python count1.py
Enter the file name: romeo.txt
{'and': 3, 'envious': 1, 'already': 1, 'fair': 1,
'is': 3, 'through': 1, 'pale': 1, 'yonder': 1,
'what': 1, 'sun': 2, 'Who': 1, 'But': 1, 'moon': 1,
'window': 1, 'sick': 1, 'east': 1, 'breaks': 1,
'grief': 1, 'with': 1, 'light': 1, 'It': 1, 'Arise': 1,
'kill': 1, 'the': 3, 'soft': 1, 'Juliet': 1}

```

It is a bit inconvenient to look through the dictionary to find the most common words and their counts, so we need to add some more Python code to get us the output that will be more helpful.

9.3 Looping and dictionaries

If you use a dictionary as the sequence in a for statement, it traverses the keys of the dictionary. For example, `print_hist` prints each key and the corresponding value:

```

def print_hist(h):
    for c in h:
        print c, h[c]

```

Here's what the output looks like:

```

>>> h = histogram('parrot')
>>> print_hist(h)

```

```
a 1
p 1
r 2
t 1
o 1
```

Again, the keys are in no particular order.

If you want to print the keys in alphabetical order, you first make a list of the keys in the dictionary using the `keys` method available in dictionary objects, and then sort that list and loop through the sorted list, looking up each key printing out key/value pairs in sorted order as follows as follows:

```
def print_sorted_hist(h):
    lst = h.keys()
    lst.sort()
    for c in lst:
        print c, h[c]
```

Here's what the output looks like:

```
>>> h = histogram('parrot')
>>> print_sorted_hist(h)
a 1
o 1
p 1
r 2
t 1
```

So now the keys are in alphabetical order.

9.4 Advanced text parsing

In the above example using the file `romeo.txt`, we made the file as simple as possible by removing any and all punctuation by hand. The real text has lots of punctuation as shown below:

```
But, soft! what light through yonder window breaks?
It is the east, and Juliet is the sun.
Arise, fair sun, and kill the envious moon,
Who is already sick and pale with grief,
```

Since the Python `split` function looks for spaces and treats words as tokens separated by spaces, we would treat the words “soft!” and “soft” as *different* words and create a separate dictionary entry for each word.

Also since the file has capitalization, we would treat “who” and “Who” as different words with different counts.

We can solve both these problems by using the string methods `lower`, `punctuation`, and `translate`. The `translate` is the most subtle of the methods. Here is the documentation for `translate`:

```
string.translate(s, table[, deletechars])
```

Delete all characters from s that are in deletechars (if present), and then translate the characters using table, which must be a 256-character string giving the translation for each character value, indexed by its ordinal. If table is None, then only the character deletion step is performed.

We will not specify the `table` but we will use the `deletechars` parameter to delete all of the punctuation. We will even let Python tell us the list of characters that it considers “punctuation”:

```
>>> import string
>>> string.punctuation
'!"#$%&\'()*+,-./:;<=>?@[\\]^_`{|}~'
```

We make the following modifications to our program:

```
import string                                     # New Code

fname = raw_input('Enter the file name: ')
try:
    fhand = open(fname)
except:
    print 'File cannot be opened:', fname
    exit()

counts = dict()
for line in fhand:
    line = line.translate(None, string.punctuation) # New Code
    line = line.lower()                             # New Code
    words = line.split()
    for word in words:
        if word not in counts:
            counts[word] = 1
        else:
            counts[word] += 1

print counts
```

We use `translate` to remove all punctuation and `lower` to force the line to lowercase. Otherwise the program is unchanged. Note for Python 2.5 and earlier, `ttranslate` does not accept `None` as the first parameter so use this code for the `translate` call:

```
print a.translate(string.maketrans(' ',' '), string.punctuation)
```

Part of learning the “Art of Python” or “Thinking Pythonically” is realizing that Python often has built-in capabilities for many common data-analysis problems. Over time, you will see enough example code and read enough of the documentation to know where to look to see if someone has already written something that makes your job much easier.

The following is an abbreviated version of the output:

```
Enter the file name: romeo-full.txt
{'swearst': 1, 'all': 6, 'afeard': 1, 'leave': 2, 'these': 2,
'kinsmen': 2, 'what': 11, 'thinkst': 1, 'love': 24, 'cloak': 1,
a': 24, 'orchard': 2, 'light': 5, 'lovers': 2, 'romeo': 40,
'maiden': 1, 'whiteupturned': 1, 'juliet': 32, 'gentleman': 1,
'it': 22, 'leans': 1, 'canst': 1, 'having': 1, ...}
```

Looking through this output is still unwieldy and we can use Python to gives us exactly what we are looking for, but to do so, we need to learn about Python **tuples**. We will pick up this example once we learn about tuples.

9.5 Debugging

As you work with bigger datasets it can become unwieldy to debug by printing and checking data by hand. Here are some suggestions for debugging large datasets:

Scale down the input: If possible, reduce the size of the dataset. For example if the program reads a text file, start with just the first 10 lines, or with the smallest example you can find. You can either edit the files themselves, or (better) modify the program so it reads only the first n lines.

If there is an error, you can reduce n to the smallest value that manifests the error, and then increase it gradually as you find and correct errors.

Check summaries and types: Instead of printing and checking the entire dataset, consider printing summaries of the data: for example, the number of items in a dictionary or the total of a list of numbers.

A common cause of runtime errors is a value that is not the right type. For debugging this kind of error, it is often enough to print the type of a value.

Write self-checks: Sometimes you can write code to check for errors automatically. For example, if you are computing the average of a list of numbers, you could check that the result is not greater than the largest element in the list or less than the smallest. This is called a “sanity check” because it detects results that are “insane.”

Another kind of check compares the results of two different computations to see if they are consistent. This is called a “consistency check.”

Pretty print the output: Formatting debugging output can make it easier to spot an error.

Again, time you spend building scaffolding can reduce the time you spend debugging.

9.6 Glossary

dictionary: A mapping from a set of keys to their corresponding values.

key: An object that appears in a dictionary as the first part of a key-value pair.

value: An object that appears in a dictionary as the second part of a key-value pair. This is more specific than our previous use of the word “value.”

key-value pair: The representation of the mapping from a key to a value.

item: Another name for a key-value pair.

implementation: A way of performing a computation.

hashtable: The algorithm used to implement Python dictionaries.

hash function: A function used by a hashtable to compute the location for a key.

lookup: A dictionary operation that takes a key and finds the corresponding value.

histogram: A set of counters.

nested loops: When there is one or more loops “inside” of another loop. The inner loop runs to completion each time the outer loop runs once.

9.7 Exercises

Exercise 9.3 Write a program that categorizes each mail message by which day of the week the commit was done. To do this look for lines which start with “From”, then look for the third word and then keep a running count of each of the days of the week. At the end of the program print out the contents of your dictionary (order does not matter).

Sample Line:

```
From stephen.marquard@uct.ac.za Sat Jan 5 09:14:16 2008
```

Sample Execution:

```
python dow.py
Enter a file name: mbox-short.txt
{'Fri': 20, 'Thu': 6, 'Sat': 1}
```

Exercise 9.4 Write a program to read through a mail log, and figure out who had the most messages in the file. The program looks for “From” lines and takes the second parameter on those lines as the person who sent the mail.

The program creates a Python dictionary that maps the sender’s address to the total number of messages for that person.

After all the data has been read the program looks through the dictionary using a maximum loop to find who has the most messages and how many messages the person has.

```
Enter a file name: mbox-short.txt
cwen@iupui.edu 5
```

```
Enter a file name: mbox.txt
zqian@umich.edu 195
```

Exercise 9.5 This program records the domain name (instead of the address) where the message was sent from instead of who the mail came from (i.e. the whole e-mail address). At the end of the program print out the contents of your dictionary.

```
python schoolcount.py
Enter a file name: mbox-short.txt
{'media.berkeley.edu': 4, 'uct.ac.za': 6, 'umich.edu': 7,
'gmail.com': 1, 'caret.cam.ac.uk': 1, 'iupui.edu': 8}
```

Chapter 10

Tuples

10.1 Tuples are immutable

A tuple is a sequence of values much like a list. The values stored in a tuple can be any type, and they are indexed by integers. The important difference is that tuples are **immutable**. Tuples are also **comparable** and **hashable** so we can sort lists of them and use tuples as key values in Python dictionaries.

Syntactically, a tuple is a comma-separated list of values:

```
>>> t = 'a', 'b', 'c', 'd', 'e'
```

Although it is not necessary, it is common to enclose tuples in parentheses to help use quickly identify tuples when we look at Python code:

```
>>> t = ('a', 'b', 'c', 'd', 'e')
```

To create a tuple with a single element, you have to include the final comma:

```
>>> t1 = ('a',)  
>>> type(t1)  
<type 'tuple'>
```

Without the comma Python treats ('a') as a string in parentheses:

```
>>> t2 = ('a')  
>>> type(t2)  
<type 'str'>
```

Another way to construct a tuple is the built-in function `tuple`. With no argument, it creates an empty tuple:

```
>>> t = tuple()  
>>> print t  
( )
```

If the argument is a sequence (string, list or tuple), the result of the call to `tuple` is a tuple with the elements of the sequence:

```
>>> t = tuple('lupins')
>>> print t
('l', 'u', 'p', 'i', 'n', 's')
```

Because `tuple` is the name of a constructor, you should avoid using it as a variable name.

Most list operators also work on tuples. The bracket operator indexes an element:

```
>>> t = ('a', 'b', 'c', 'd', 'e')
>>> print t[0]
'a'
```

And the slice operator selects a range of elements.

```
>>> print t[1:3]
('b', 'c')
```

But if you try to modify one of the elements of the tuple, you get an error:

```
>>> t[0] = 'A'
TypeError: object doesn't support item assignment
```

You can't modify the elements of a tuple, but you can replace one tuple with another:

```
>>> t = ('A',) + t[1:]
>>> print t
('A', 'b', 'c', 'd', 'e')
```

10.2 Comparing tuples

The comparison operators work with tuples and other sequences; Python starts by comparing the first element from each sequence. If they are equal, it goes on to the next element, and so on, until it finds elements that differ. Subsequent elements are not considered (even if they are really big).

```
>>> (0, 1, 2) < (0, 3, 4)
True
>>> (0, 1, 2000000) < (0, 3, 4)
True
```

The `sort` function works the same way. It sorts primarily by first element, but in the case of a tie, it sorts by second element, and so on.

This feature lends itself to a pattern called **DSU** for

Decorate a sequence by building a list of tuples with one or more sort keys preceding the elements from the sequence,

Sort the list of tuples using the Python built-in `sort`, and

Undecorate by extracting the sorted elements of the sequence.

For example, suppose you have a list of words and you want to sort them from longest to shortest:

```
def sort_by_length(words):
    t = list()
    for word in words:
        t.append((len(word), word))

    t.sort(reverse=True)

    res = list()
    for length, word in t:
        res.append(word)
    return res
```

The first loop builds a list of tuples, where each tuple is a word preceded by its length.

`sort` compares the first element, `length`, first, and only considers the second element to break ties. The keyword argument `reverse=True` tells `sort` to go in decreasing order.

The second loop traverses the list of tuples and builds a list of words in descending order of length.

10.3 Tuple assignment

One of the unique syntactic features of the Python language is the ability to have a tuple on the left hand side of an assignment statement. This allows you to assign more than one variable at a time when the left hand side is a sequence.

In this example we have a two element list (which is a sequence) and assign the first and second elements of the sequence to the variables `x` and `y` in a single statement.

```
>>> m = [ 'have', 'fun' ]
>>> x, y = m
>>> x
'have'
>>> y
'fun'
>>>
```

It is not magic, Python *roughly* translates the tuple assignment syntax to be the following:¹

¹Python does not translate the syntax literally. For example if you try this with a dictionary it will not work as might expect.

```
>>> m = [ 'have', 'fun' ]
>>> x = m[0]
>>> y = m[1]
>>> x
'have'
>>> y
'fun'
>>>
```

Stylistically when we use a tuple on the left hand side of the assignment statement, we omit the parentheses, but the following is an equally valid syntax:

```
>>> m = [ 'have', 'fun' ]
>>> (x, y) = m
>>> x
'have'
>>> y
'fun'
>>>
```

A particularly clever application of tuple assignment allows us to **swap** the values of two variables in a single statement:

```
>>> a, b = b, a
```

Both sides of this statement are tuples, but the left side is a tuple of variables; the right side is a tuple of expressions. Each value on the right side is assigned to its respective variable on the left side. All the expressions on the right side are evaluated before any of the assignments.

The number of variables on the left and the number of values on the right have to be the same:

```
>>> a, b = 1, 2, 3
ValueError: too many values to unpack
```

More generally, the right side can be any kind of sequence (string, list or tuple). For example, to split an email address into a user name and a domain, you could write:

```
>>> addr = 'monty@python.org'
>>> uname, domain = addr.split('@')
```

The return value from `split` is a list with two elements; the first element is assigned to `uname`, the second to `domain`.

```
>>> print uname
monty
>>> print domain
python.org
```

10.4 Dictionaries and tuples

Dictionaries have a method called `items` that returns a list of tuples, where each tuple is a key-value pair².

```
>>> d = {'a':10, 'b':1, 'c':22}
>>> t = d.items()
>>> print t
[('a', 10), ('c', 22), ('b', 1)]
```

As you should expect from a dictionary, the items are in no particular order.

However, since the list of tuples is a list, and tuples are comparable, we can now sort the list of tuples. Converting a dictionary to a list of tuples is a way for us to output the contents of a dictionary sorted by key:

```
>>> d = {'a':10, 'b':1, 'c':22}
>>> t = d.items()
>>> t
[('a', 10), ('c', 22), ('b', 1)]
>>> t.sort()
>>> t
[('a', 10), ('b', 1), ('c', 22)]
```

The new list is sorted in ascending alphabetical order by the key value.

10.5 Multiple assignment with dictionaries

Combining `items`, tuple assignment and `for`, you can see a nice code pattern for traversing the keys and values of a dictionary in a single loop:

```
for key, val in d.items():
    print val, key
```

This loop has two **iteration variables** because `items` returns a list of tuples and `key, val` is a tuple assignment that successively iterates through each of the key/value pairs in the dictionary.

For each iteration through the loop, both `key` and `value` are advanced to the next key/value pair in the dictionary (still in hash order).

The output of this loop is:

```
0 a
2 c
1 b
```

²This behavior is slightly different in Python 3.0.

Again in hash key order (i.e. no particular order).

If we combine these two techniques, we can print out the contents of a dictionary sorted by the *value* stored in each key/value pair.

To do this, we first make a list of tuples where each tuple is (value, key). The `items` method would give us a list of (key, value) tuples—but this time we want to sort by value not key. Once we have constructed the list with the value/key tuples, it is a simple matter to sort the list in reverse order and print out the new, sorted list.

```
>>> d = {'a':10, 'b':1, 'c':22}
>>> l = list()
>>> for key, val in d.items() :
...     l.append( (val, key) )
...
>>> l
[(10, 'a'), (22, 'c'), (1, 'b')]
>>> l.sort(reverse=True)
>>> l
[(22, 'c'), (10, 'a'), (1, 'b')]
>>>
```

By hand-constructing the list of tuples to have the value as the first element of each tuple, we can sort the list of tuples and get our dictionary contents sorted by value.

10.6 The most common words

Coming back to our running example of the text from *Romeo and Juliet* Act 2, Scene 2, we can augment our program to use this technique to print the ten most common words in the text as follows:

```
import string
fhand = open('romeo-full.txt')
counts = dict()
for line in fhand:
    line = line.translate(None, string.punctuation)
    line = line.lower()
    words = line.split()
    for word in words:
        if word not in counts:
            counts[word] = 1
        else:
            counts[word] += 1

# Sort the dictionary by value
lst = list()
for key, val in counts.items():
```



```
lst.append( (val, key) )

lst.sort(reverse=True)

for key, val in lst[:10] :
    print key, val
```

The first part of the program which reads the file and computes the dictionary that maps each word to the count of words in the document is unchanged. But instead of simply printing out counts and ending the program, we construct a list of `(val, key)` tuples and then sort the list in reverse order.

Since the value is first, it will be used for the comparisons and if there is more than one tuple with the same value, it will look at the second element (the key) so tuples where the value is the same will be further sorted by the alphabetical order of the key.

At the end we write a nice `for` loop which does a multiple assignment iteration and prints out the ten most common words by iterating through a slice of the list (`lst[:10]`).

So now the output finally looks like what we want for our word frequency analysis.

```
61 i
42 and
40 romeo
34 to
34 the
32 thou
32 juliet
30 that
29 my
24 thee
```

The fact that this relatively complex data parsing and analysis can be done with a relatively easy-to-understand 19 line Python program is one reason why Python is a good choice as a language for exploring information.

10.7 Using tuples as keys in dictionaries

Because tuples are **hashable** and lists are not, if we want to create a **composite** key to use in a dictionary we must use a tuple as the key.

We would encounter a composite key if we wanted to create a telephone directory that maps from last-name, first-name pairs to telephone numbers. Assuming that we have defined the variables `last`, `first` and `number`, we could write a dictionary assignment statement as follows:

```
directory[last,first] = number
```

The expression in brackets is a tuple. We could use tuple assignment in a for loop to traverse this dictionary.

```
for last, first in directory:
    print first, last, directory[last,first]
```

This loop traverses the keys in `directory`, which are tuples. It assigns the elements of each tuple to `last` and `first`, then prints the name and corresponding telephone number.

There are two ways to represent tuples in a state diagram. The more detailed version shows the indices and elements just as they appear in a list. For example, the tuple `('Cleese', 'John')` would appear:

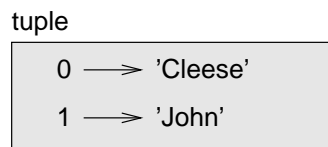

But in a larger diagram you might want to leave out the details. For example, a diagram of the telephone directory might appear:

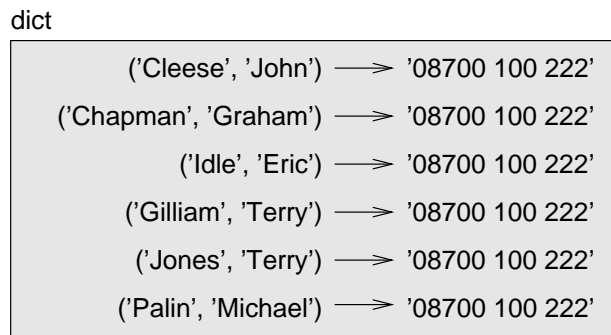

Here the tuples are shown using Python syntax as a graphical shorthand.

The telephone number in the diagram is the complaints line for the BBC, so please don't call it.

10.8 Sequences: strings, lists, and tuples—Oh My!

I have focused on lists of tuples, but almost all of the examples in this chapter also work with lists of lists, tuples of tuples, and tuples of lists. To avoid enumerating the possible combinations, it is sometimes easier to talk about sequences of sequences.

In many contexts, the different kinds of sequences (strings, lists and tuples) can be used interchangeably. So how and why do you choose one over the others?

To start with the obvious, strings are more limited than other sequences because the elements have to be characters. They are also immutable. If you need the ability to change the

characters in a string (as opposed to creating a new string), you might want to use a list of characters instead.

Lists are more common than tuples, mostly because they are mutable. But there are a few cases where you might prefer tuples:

1. In some contexts, like a return statement, it is syntactically simpler to create a tuple than a list. In other contexts, you might prefer a list.
2. If you want to use a sequence as a dictionary key, you have to use an immutable type like a tuple or string.
3. If you are passing a sequence as an argument to a function, using tuples reduces the potential for unexpected behavior due to aliasing.

Because tuples are immutable, they don't provide methods like `sort` and `reverse`, which modify existing lists. However Python provides the built-in functions `sorted` and `reversed`, which take any sequence as a parameter and return a new list with the same elements in a different order.

10.9 Debugging

Lists, dictionaries and tuples are known generically as **data structures**; in this chapter we are starting to see compound data structures, like lists of tuples, and dictionaries that contain tuples as keys and lists as values. Compound data structures are useful, but they are prone to what I call **shape errors**; that is, errors caused when a data structure has the wrong type, size or composition or perhaps you write some code and forget the shape of your data and introduce an error.

For example, if you are expecting a list with one integer and I give you a plain old integer (not in a list), it won't work.

When you are debugging a program, and especially if you are working on a hard bug, there are four things to try:

reading: Examine your code, read it back to yourself, and check that it says what you meant to say.

running: Experiment by making changes and running different versions. Often if you display the right thing at the right place in the program, the problem becomes obvious, but sometimes you have to spend some time to build scaffolding.

ruminating: Take some time to think! What kind of error is it: syntax, runtime, semantic? What information can you get from the error messages, or from the output of the program? What kind of error could cause the problem you're seeing? What did you change last, before the problem appeared?

retreating: At some point, the best thing to do is back off, undoing recent changes, until you get back to a program that works and that you understand. Then you can start rebuilding.

Beginning programmers sometimes get stuck on one of these activities and forget the others. Each activity comes with its own failure mode.

For example, reading your code might help if the problem is a typographical error, but not if the problem is a conceptual misunderstanding. If you don't understand what your program does, you can read it 100 times and never see the error, because the error is in your head.

Running experiments can help, especially if you run small, simple tests. But if you run experiments without thinking or reading your code, you might fall into a pattern I call "random walk programming," which is the process of making random changes until the program does the right thing. Needless to say, random walk programming can take a long time.

You have to take time to think. Debugging is like an experimental science. You should have at least one hypothesis about what the problem is. If there are two or more possibilities, try to think of a test that would eliminate one of them.

Taking a break helps with the thinking. So does talking. If you explain the problem to someone else (or even yourself), you will sometimes find the answer before you finish asking the question.

But even the best debugging techniques will fail if there are too many errors, or if the code you are trying to fix is too big and complicated. Sometimes the best option is to retreat, simplifying the program until you get to something that works and that you understand.

Beginning programmers are often reluctant to retreat because they can't stand to delete a line of code (even if it's wrong). If it makes you feel better, copy your program into another file before you start stripping it down. Then you can paste the pieces back in a little bit at a time.

Finding a hard bug requires reading, running, ruminating, and sometimes retreating. If you get stuck on one of these activities, try the others.

10.10 Glossary

tuple: An immutable sequence of elements.

hashable: A type that has a hash function. Immutable types like integers, floats and strings are hashable; mutable types like lists and dictionaries are not.

comparable: A type where one value can be checked to see if it is greater than, less than or equal to another value of the same type. Types which are comparable can be put in a list and sorted.

tuple assignment: An assignment with a sequence on the right side and a tuple of variables on the left. The right side is evaluated and then its elements are assigned to the variables on the left.

singleton: A list (or other sequence) with a single element.

gather: The operation of assembling a variable-length argument tuple.

scatter: The operation of treating a sequence as a list of arguments.

DSU: Abbreviation of “decorate-sort-undecorate,” a pattern that involves building a list of tuples, sorting, and extracting part of the result.

data structure: A collection of related values, often organized in lists, dictionaries, tuples, etc.

shape (of a data structure): A summary of the type, size and composition of a data structure.

10.11 Exercises

Exercise 10.1 Revise a previous program as follows: Read and parse the “From” lines and pull out the addresses from the line. Count the number of messages from each person using a dictionary.

After all the data has been read print the person with the most commits by creating a list of (count, email) tuples from the dictionary and then sorting the list in reverse order and print out the person who has the most commits.

Sample Line:

```
From stephen.marquard@uct.ac.za Sat Jan 5 09:14:16 2008
```

```
Enter a file name: mbox-short.txt
```

```
cwen@iupui.edu 5
```

```
Enter a file name: mbox.txt
```

```
zqian@umich.edu 195
```

Exercise 10.2 This program counts the distribution of the hour of the day for each of the messages. You can pull the hour from the “From” line by finding the time string and then splitting that string into parts using the colon character. Once you have accumulated the counts for each hour, print out the counts, one per line, sorted by hour as shown below.

Sample Execution:

```
python timeofday.py
```

```
Enter a file name: mbox-short.txt
```

```
04 3
```

```
06 1
```

```
07 1
```

```
09 2
```

```
10 3
```

```
11 6
```

```
14 1
```

15 2
16 4
17 2
18 1
19 1

Exercise 10.3 Write a function called `most_frequent` that takes a string and prints the letters in decreasing order of frequency. Find text samples from several different languages and see how letter frequency varies between languages. Compare your results with the tables at wikipedia.org/wiki/Letter_frequencies.

Chapter 11

Automating common tasks on your computer

Up to now, we have focused on writing programs that read the data in a single file. Python can also read data from a network, database, or even look through all the folders on your computer.

In this chapter, we will write programs that scan through your computer and perform some operation on each file. Files are organized into directories (also called “folders”). Simple Python scripts can make short work of simple tasks that must be done to hundreds or thousands of files spread across a directory tree or your entire computer.

To walk through all the directories and files in a tree we use `os.walk` and a `for` loop. This is similar to how `open` allows us to write a loop to read the contents of a file, `socket` allows us to write a loop to read the contents of a network connection, and `urllib` allows us to open a web document and loop through its contents.

11.1 File names and paths

Every running program has a “current directory,” which is the default directory for most operations. For example, when you open a file for reading, Python looks for it in the current directory.

The `os` module provides functions for working with files and directories (`os` stands for “operating system”). `os.getcwd` returns the name of the current directory:

```
>>> import os
>>> cwd = os.getcwd()
>>> print cwd
/home/dinsdale
```

`cwd` stands for **current working directory**. The result in this example is `/home/dinsdale`, which is the home directory of a user named `dinsdale`.

A string like `cwd` that identifies a file is called a path. A **relative path** starts from the current directory; an **absolute path** starts from the topmost directory in the file system.

The paths we have seen so far are simple file names, so they are relative to the current directory. To find the absolute path to a file, you can use `os.path.abspath`:

```
>>> os.path.abspath('memo.txt')
'/home/dinsdale/memo.txt'
```

`os.path.exists` checks whether a file or directory exists:

```
>>> os.path.exists('memo.txt')
True
```

If it exists, `os.path.isdir` checks whether it's a directory:

```
>>> os.path.isdir('memo.txt')
False
>>> os.path.isdir('music')
True
```

Similarly, `os.path.isfile` checks whether it's a file.

`os.listdir` returns a list of the files (and other directories) in the given directory:

```
>>> os.listdir(cwd)
['music', 'photos', 'memo.txt']
```

11.2 Example: Cleaning up a photo directory

Some time ago, I built a bit of Flickr-like software that received photos from my cellphone and stored those photos on my server. I wrote this before Flickr existed and kept using it after Flickr existed because I wanted to keep original copies of my images forever.

I would also send a simple one-line text description in the MMS message or the subject line of the E-Mail message. I stored these messages in a text file in the same directory as the image file. I came up with a directory structure based on the month, year, day and time the photo was taken. The following would be an example of the naming for one photo and its existing description:

```
./2006/03/24-03-06_2018002.jpg
./2006/03/24-03-06_2018002.txt
```

After seven years, I had a lot of photos and captions. Over the years as I switched cell phones, sometimes my code to extract the caption from the message would break and add a bunch of useless data on my server instead of a caption.

I wanted to go through these files and figure out which of the text files were really captions and which were junk and then delete the bad files. The first thing to do was to get a simple inventory of how many text files I had in of the sub-folders using the following program:

```
import os
count = 0
for (dirname, dirs, files) in os.walk('.'):
    for filename in files:
        if filename.endswith('.txt') :
            count = count + 1
print 'Files:', count
```

```
python txtcount.py
Files: 1917
```

The key bit of code that makes this possible is the `os.walk` library in Python. When we call `os.walk` and give it a starting directory, it will “walk” through all of the directories and sub-directories recursively. The string “.” indicates to start in the current directory and walk downward. As it encounters each directory, we get three values in a tuple in the body of the `for` loop. The first value is the current directory name, the second value is the list of sub-directories in the current directory, and the third value is a list of files in the current directory.

We do not have to explicitly look into each of the sub-directories because we can count on `os.walk` to visit every folder eventually. But we do want to look at each file, so we write a simple `for` loop to examine each of the files in the current directory. We check each file to see if it ends with “.txt” and then count the number of files through the whole directory tree that end with the suffix “.txt”.

Once we have a sense of how many files end with “.txt”, the next thing to do is try to automatically determine in Python which files are bad and which files are good. So we write a simple program to print out the files and the size of each file:

```
import os
from os.path import join
for (dirname, dirs, files) in os.walk('.'):
    for filename in files:
        if filename.endswith('.txt') :
            thefile = os.path.join(dirname,filename)
            print os.path.getsize(thefile), thefile
```

Now instead of just counting the files, we create a file name by concatenating the directory name with the name of the file within the directory using `os.path.join`. It is important to use `os.path.join` instead of string concatenation because on Windows we use a backslash (\) to construct file paths and on Linux or Apple we use a forward slash (/) to construct file paths. The `os.path.join` knows these differences and knows what system we are running on and it does the proper concatenation depending on the system. So the same Python code runs on either Windows or UNIX-style systems.

Once we have the full file name with directory path, we use the `os.path.getsize` utility to get the size and print it out, producing the following output:

```
python txtsize.py
...
18 ./2006/03/24-03-06_2303002.txt
22 ./2006/03/25-03-06_1340001.txt
22 ./2006/03/25-03-06_2034001.txt
...
2565 ./2005/09/28-09-05_1043004.txt
2565 ./2005/09/28-09-05_1141002.txt
...
2578 ./2006/03/27-03-06_1618001.txt
2578 ./2006/03/28-03-06_2109001.txt
2578 ./2006/03/29-03-06_1355001.txt
...
```

Scanning the output, we notice that some files are pretty short and a lot of the files are pretty large and the same size (2578 and 2565). When we take a look at a few of these larger files by hand, it looks like the large files are nothing but a generic bit of identical HTML that came in from mail sent to my system from my T-Mobile phone:

```
<html>
    <head>
        <title>T-Mobile</title>
    ...
```

Skimming through the file, it looks like there is no good information in these files so we can probably delete them.

But before we delete the files, we will write a program to look for files that are more than one line long and show the contents of the file. But let's not bother showing ourselves those files that are exactly 2578 or 2565 characters long since we know that these files have no useful information.

So we write the following program:

```
import os
from os.path import join
for (dirname, dirs, files) in os.walk('.'):
    for filename in files:
        if filename.endswith('.txt') :
            thefile = os.path.join(dirname,filename)
            size = os.path.getsize(thefile)
            if size == 2578 or size == 2565:
                continue
            fhand = open(thefile,'r')
            lines = list()
```

```
for line in fhand:
    lines.append(line)
fhand.close()
if len(lines) > 1:
    print len(lines), thefile
    print lines[:4]
```

We use a `continue` to skip files with the two “bad sizes”, then open the rest of the files and read the lines of the file into a Python list and if the file has more than one line we print out how many lines are in the file and print out the first three lines.

It looks like filtering out those two bad file sizes, and assuming that all one-line files are correct, we are down to some pretty clean data:

```
python txtcheck.py
3 ./2004/03/22-03-04_2015.txt
['Little horse rider\r\n', '\r\n', '\r']
2 ./2004/11/30-11-04_1834001.txt
['Testing 123.\n', '\n']
3 ./2007/09/15-09-07_074202_03.txt
['\r\n', '\r\n', 'Sent from my iPhone\r\n']
3 ./2007/09/19-09-07_124857_01.txt
['\r\n', '\r\n', 'Sent from my iPhone\r\n']
3 ./2007/09/20-09-07_115617_01.txt
...
```

But there is one more annoying pattern of files: there are some three-line files that consist of two blank lines followed by a line that says “Sent from my iPhone” that have slipped into my data. So we make the following change to the program to deal with these files as well.

```
lines = list()
for line in fhand:
    lines.append(line)
if len(lines) == 3 and lines[2].startswith('Sent from my iPhone') :
    continue
if len(lines) > 1:
    print len(lines), thefile
    print lines[:4]
```

We simply check if we have a three-line file, and if the third line starts with the specified text, we skip it.

Now when we run the program, we only see four remaining multi-line files and all of those files look pretty reasonable:

```
python txtcheck2.py
3 ./2004/03/22-03-04_2015.txt
```

```
['Little horse rider\r\n', '\r\n', '\r']
2 ./2004/11/30-11-04_1834001.txt
['Testing 123.\n', '\n']
2 ./2006/03/17-03-06_1806001.txt
['On the road again...\r\n', '\r\n']
2 ./2006/03/24-03-06_1740001.txt
['On the road again...\r\n', '\r\n']
```

If you look at the overall pattern of this program, we have successively refined how we accept or reject files and once we found a pattern that was “bad” we used `continue` to skip the bad files so we could refine our code to find more file patterns that were bad.

Now we are getting ready to delete the files, so we are going to flip the logic and instead of printing out the remaining good files, we will print out the “bad” files that we are about to delete.

```
import os
from os.path import join
for (dirname, dirs, files) in os.walk('.'):
    for filename in files:
        if filename.endswith('.txt') :
            thefile = os.path.join(dirname,filename)
            size = os.path.getsize(thefile)
            if size == 2578 or size == 2565:
                print 'T-Mobile:',thefile
                continue
            fhand = open(thefile,'r')
            lines = list()
            for line in fhand:
                lines.append(line)
            fhand.close()
            if len(lines) == 3 and lines[2].startswith('Sent from my iPhone') :
                print 'iPhone:', thefile
                continue
```

We can now see a list of candidate files that we are about to delete and why these files are up for deleting. The program produces the following output:

```
python txtcheck3.py
...
T-Mobile: ./2006/05/31-05-06_1540001.txt
T-Mobile: ./2006/05/31-05-06_1648001.txt
iPhone: ./2007/09/15-09-07_074202_03.txt
iPhone: ./2007/09/15-09-07_144641_01.txt
iPhone: ./2007/09/19-09-07_124857_01.txt
...
```

We can spot-check these files to make sure that we did not inadvertently end up introducing a bug in our program or perhaps our logic caught some files we did not want to catch.

Once we are satisfied that this is the list of files we want to delete, we make the following change to the program:

```
        if size == 2578 or size == 2565:
            print 'T-Mobile:', thefile
            os.remove(thefile)
            continue
    ...
        if len(lines) == 3 and lines[2].startswith('Sent from my iPhone') :
            print 'iPhone:', thefile
            os.remove(thefile)
            continue
```

In this version of the program, we will both print the file out and remove the bad files using `os.remove`.

```
python txtdelete.py
T-Mobile: ./2005/01/02-01-05_1356001.txt
T-Mobile: ./2005/01/02-01-05_1858001.txt
...
```

Just for fun, run the program a second time and it will produce no output since the bad files are already gone.

If we rerun `txtcount.py` we can see that we have removed 899 bad files:

```
python txtcount.py
Files: 1018
```

In this section, we have followed a sequence where we use Python to first look through directories and files seeking patterns. We slowly use Python to help determine what we want to do to clean up our directories. Once we figure out which files are good and which files are not useful, we use Python to delete the files and perform the cleanup.

The problem you may need to solve can either be quite simple and might only depend on looking at the names of files, or perhaps you need to read every single file and look for patterns within the files. Sometimes you will need to read all the files and make a change to some of the files. All of these are pretty straightforward once you understand how `os.walk` and the other `os` utilities can be used.

11.3 Command line arguments

In earlier chapters, we had a number of programs that prompted for a file name using `raw_input` and then read data from the file and processed the data as follows:

```
name = raw_input('Enter file:')
handle = open(name, 'r')
text = handle.read()
...
```

We can simplify this program a bit by taking the file name from the command line when we start Python. Up to now, we simply run our Python programs and respond to the prompts as follows:

```
python words.py
Enter file: mbox-short.txt
...
```

We can place additional strings after the Python file and access those **command line arguments** in our Python program. Here is a simple program that demonstrates reading arguments from the command line:

```
import sys
print 'Count:', len(sys.argv)
print 'Type:', type(sys.argv)
for arg in sys.argv:
    print 'Argument:', arg
```

The contents of `sys.argv` are a list of strings where the first string is the name of the Python program and the remaining strings are the arguments on the command line after the Python file.

The following shows our program reading several command line arguments from the command line:

```
python argtest.py hello there
Count: 3
Type: <type 'list'>
Argument: argtest.py
Argument: hello
Argument: there
```

There are three arguments are passed into our program as a three-element list. The first element of the list is the file name (`argtest.py`) and the others are the two command line arguments after the file name.

We can rewrite our program to read the file, taking the file name from the command line argument as follows:

```
import sys

name = sys.argv[1]
handle = open(name, 'r')
text = handle.read()
print name, 'is', len(text), 'bytes'
```

We take the second command line argument as the name of the file (skipping past the program name in the [0] entry). We open the file and read the contents as follows:

```
python argfile.py mbox-short.txt
mbox-short.txt is 94626 bytes
```

Using command line arguments as input can make it easier to reuse your Python programs especially when you only need to input one or two strings.

11.4 Pipes

Most operating systems provide a command-line interface, also known as a **shell**. Shells usually provide commands to navigate the file system and launch applications. For example, in Unix, you can change directories with `cd`, display the contents of a directory with `ls`, and launch a web browser by typing (for example) `firefox`.

Any program that you can launch from the shell can also be launched from Python using a **pipe**. A pipe is an object that represents a running process.

For example, the Unix command¹ `ls -l` normally displays the contents of the current directory (in long format). You can launch `ls` with `os.popen`:

```
>>> cmd = 'ls -l'
>>> fp = os.popen(cmd)
```

The argument is a string that contains a shell command. The return value is a file pointer that behaves just like an open file. You can read the output from the `ls` process one line at a time with `readline` or get the whole thing at once with `read`:

```
>>> res = fp.read()
```

When you are done, you close the pipe like a file:

```
>>> stat = fp.close()
>>> print stat
None
```

The return value is the final status of the `ls` process; `None` means that it ended normally (with no errors).

11.5 Glossary

absolute path: A string that describes where a file or directory is stored that starts at the “top of the tree of directories” so that it can be used to access the file or directory, regardless of the current working directory.

¹When using pipes to talk to operating system commands like `ls`, it is important for you to know which operating system you are using and only open pipes to commands that are supported on your operating system.

checksum: See also **hashing**. The term “checksum” comes from the need to verify if data was garbled as it was sent across a network or written to a backup medium and then read back in. When the data is written or sent, the sending system computes a checksum and also sends the checksum. When the data is read or received, the receiving system re-computes the checksum from the received data and compares it to the received checksum. If the checksums do not match, we must assume that the data was garbled as it was transferred.

command line argument: Parameters on the command line after the Python file name.

current working directory: The current directory that you are “in”. You can change your working directory using the `cd` command on most systems in their command-line interfaces. When you open a file in Python using just the file name with no path information the file must be in the current working directory where you are running the program.

hashing: Reading through a potentially large amount of data and producing a unique checksum for the data. The best hash functions produce very few “collisions” where you can give two different streams of data to the hash function and get back the same hash. MD5, SHA1, and SHA256 are examples of commonly used hash functions.

pipe: A pipe is a connection to a running program. Using a pipe, you can write a program to send data to another program or receive data from that program. A pipe is similar to a **socket** except that a pipe can only be used to connect programs running on the same computer (i.e. not across a network).

relative path: A string that describes where a file or directory is stored relative to the current working directory.

shell: A command-line interface to an operating system. Also called a “terminal program” in some systems. In this interface you type a command and parameters on a line and press “enter” to execute the command.

walk: A term we use to describe the notion of visiting the entire tree of directories, sub-directories, sub-sub-directories, until we have visited the all of the directories. We call this “walking the directory tree”.

11.6 Exercises

Exercise 11.1 In a large collection of MP3 files there may be more than one copy of the same song, stored in different directories or with different file names. The goal of this exercise is to search for these duplicates.

1. Write a program that walks a directory and all of its sub-directories for all files with a given suffix (like `.mp3`) and lists pairs of files with that are the same size. Hint: Use a dictionary where the key of the dictionary is the size of the file from `os.path.getsize` and the value in the dictionary is the path name concatenated with the file name. As you encounter each file check to see if you already have a file

that has the same size as the current file. If so, you have a duplicate size file and print out the file size and the two files names (one from the hash and the other file you are looking at).

2. Adapt the previous program to look for files that have duplicate content using a hashing or **checksum** algorithm. For example, MD5 (Message-Digest algorithm 5) takes an arbitrarily-long “message” and returns a 128-bit “checksum.” The probability is very small that two files with different contents will return the same checksum.

You can read about MD5 at wikipedia.org/wiki/Md5. The following code snippet opens a file, reads it and computes its checksum.

```
import hashlib
...
        fhand = open(thefile, 'r')
        data = fhand.read()
        fhand.close()
        checksum = hashlib.md5(data).hexdigest()
```

You should create a dictionary where the checksum is the key and the file name is the value. When you compute a checksum and it is already in the dictionary as a key, you have two files with duplicate content so print out the file in the dictionary and the file you just read. Here is some sample output from a run in a folder of image files:

```
./2004/11/15-11-04_0923001.jpg ./2004/11/15-11-04_1016001.jpg
./2005/06/28-06-05_1500001.jpg ./2005/06/28-06-05_1502001.jpg
./2006/08/11-08-06_205948_01.jpg ./2006/08/12-08-06_155318_02.jpg
./2006/09/28-09-06_225657_01.jpg ./2006/09-50-years/28-09-06_225657_01.jpg
./2006/09/29-09-06_002312_01.jpg ./2006/09-50-years/29-09-06_002312_01.jpg
```

Apparently I sometimes sent the same photo more than once or made a copy of a photo from time to time without deleting the original.

Chapter 12

Networked programs

While many of the examples in this book have focused on reading files and looking for data in those files, there are many different sources of information when one considers the Internet.

In this chapter we will pretend to be a web browser and retrieve web pages using the HyperText Transport Protocol (HTTP). Then we will read through the web page data and parse it.

12.1 HyperText Transport Protocol - HTTP

The network protocol that powers the web is actually quite simple and there is built-in support in Python called `sockets` which makes it very easy to make network connections and retrieve data over those sockets in a Python program.

A **socket** is much like a file, except that it provides a two-way connection between two programs with a single socket. You can both read from and write to the same socket. If you write something to a socket it is sent to the application at the other end of the socket. If you read from the socket, you are given the data which the other application has sent.

But if you try to read a socket when the program on the other end of the socket has not sent any data - you just sit and wait. If the programs on both ends of the socket simply wait for some data without sending anything, they will wait for a very long time.

So an important part of programs that communicate over the Internet is to have some sort of protocol. A protocol is a set of precise rules that determine who is to go first, what they are to do, and then what are the responses to that message, and who sends next and so on. In a sense the two applications at either end of the socket are doing a dance and making sure not to step on each other's toes.

There are many documents which describe these network protocols. The HyperText Transport Protocol is described in the following document:

`http://www.w3.org/Protocols/rfc2616/rfc2616.txt`

This is a long and complex 176 page document with a lot of detail. If you find it interesting feel free to read it all. But if you take a look around page 36 of RFC2616 you will find the syntax for the GET request. If you read in detail, you will find that to request a document from a web server, we make a connection to the `www.py4inf.com` server on port 80, and then send a line of the form:

```
GET http://www.py4inf.com/code/romeo.txt HTTP/1.0
```

Where the second parameter is the web page we are requesting and then we also send a blank line. The web server will respond with some header information about the document and a blank line followed by the document content.

12.2 The World's Simplest Web Browser

Perhaps the easiest way to show how the HTTP protocol works is to write a very simple Python program that makes a connection to a web server and following the rules of the HTTP protocol, requests a document and displays what the server sends back.

```
import socket

mysock = socket.socket(socket.AF_INET, socket.SOCK_STREAM)
mysock.connect(('www.py4inf.com', 80))
mysock.send('GET http://www.py4inf.com/code/romeo.txt HTTP/1.0\n\n')

while True:
    data = mysock.recv(512)
    if ( len(data) < 1 ) :
        break
    print data

mysock.close()
```

First the program makes a connection to port 80 on the server `www.py4inf.com`. Since our program is playing the role of the “web browser” the HTTP protocol says we must send the GET command followed by a blank line.

Once we send that blank line, we write a loop that receives data in 512 character chunks from the socket and prints the data out until there is no more data to read (i.e. the `recv()` returns an empty string).

The program produces the following output:

```
HTTP/1.1 200 OK
Date: Sun, 14 Mar 2010 23:52:41 GMT
Server: Apache
Last-Modified: Tue, 29 Dec 2009 01:31:22 GMT
```

```
ETag: "143c1b33-a7-4b395bea"  
Accept-Ranges: bytes  
Content-Length: 167  
Connection: close  
Content-Type: text/plain
```

```
But soft what light through yonder window breaks  
It is the east and Juliet is the sun  
Arise fair sun and kill the envious moon  
Who is already sick and pale with grief
```

The output starts with headers which the web server sends to describe the document. For example, the `Content-Type` header indicated that the document is a plain text document (`text/plain`).

After the server sends us the headers, it adds a blank line to indicate the end of the headers and then sends the actual data of the file `romeo.txt`.

This example shows how to make a low-level network connection with sockets. Sockets can be used to communicate with a web server or with a mail server or many other kinds of servers. All that is needed is to find the document which describes the protocol and write the code to send and receive the data according to the protocol.

However, since the protocol that we use most commonly is the HTTP (i.e. the web) protocol, Python has a special library specifically designed to support the HTTP protocol for the retrieval of documents and data over the web.

12.3 Retrieving web pages with `urllib`

The `urllib` library makes it very easy to retrieve web pages and process the data in Python. Using `urllib` you can treat a web page much like a file. You simply indicate which web page you would like to retrieve and `urllib` handles all of the HTTP protocol details.

The equivalent code to read the `romeo.txt` file from the web using `urllib` is as follows:

```
import urllib  
  
fhand = urllib.urlopen('http://www.py4inf.com/code/romeo.txt')  
for line in fhand:  
    print line.strip()
```

Once the web page has been opened with `urllib.urlopen` we can treat it like a file and read through it using a `for` loop.

When the program runs, we only see the output of the contents of the file. The headers are still sent, but the `urllib` code consumes the headers and only returns the data to us.

```
But soft what light through yonder window breaks
It is the east and Juliet is the sun
Arise fair sun and kill the envious moon
Who is already sick and pale with grief
```

As an example, we can write a program to retrieve the data for `romeo.txt` and compute the frequency of each word in the file as follows:

```
import urllib

counts = dict()
fhand = urllib.urlopen('http://www.py4inf.com/code/romeo.txt')
for line in fhand:
    words = line.split()
    for word in words:
        counts[word] = counts.get(word,0) + 1
print counts
```

Again, once we have opened the web page, we can read it like a local file.

12.4 Parsing HTML and scraping the web

One of the common uses of the `urllib` capability in Python is to **scrape** the web. Web scraping is when we write a program that pretends to be a web browser and retrieves pages and then examines the data in those pages looking for patterns.

As an example, a search engine such as Google will look at the source of one web page and extract the links to other pages and retrieve those pages, extracting links, and so on. Using this technique, Google **spiders** its way through nearly all of the pages on the web. Google also uses the frequency of links from pages it finds to a particular page as one measure of how “important” a page is and how highly the page should appear in its search results.

There are a number of Python libraries which can help you parse HTML and extract data from the pages. Each of the libraries has its strengths and weaknesses and you can pick one based on your needs.

As an example, we will simply parse some HTML input and extract links using the **BeautifulSoup** library. You can download and install the BeautifulSoup code from:

www.crummy.com

You can download and “install” BeautifulSoup or you can simply place the `BeautifulSoup.py` file in the same folder as your application.

Even though HTML looks like XML and some pages are carefully constructed to be XML, most HTML is generally broken in ways that cause an XML parser to reject the entire page of HTML as improperly formed. BeautifulSoup tolerates highly flawed HTML and still lets you easily extract the data you need.

Here is a simple web page:

```
<h1>The First Page</h1>
<p>
If you like, you can switch to the
<a href="http://www.dr-chuck.com/page2.htm">
Second Page</a>.
</p>
```

We will use `urllib` to read the page and then use `BeautifulSoup` to extract the `href` attributes from the anchor (`a`) tags.

```
import urllib
from BeautifulSoup import *

url = raw_input('Enter - ')
html = urllib.urlopen(url).read
soup = BeautifulSoup(html)

# Retrieve all of the anchor tags
tags = soup('a')
for tag in tags:
    print tag.get('href', None)
```

The program prompts for a web address, then opens the web page, reads the data and passes the data to the `BeautifulSoup` parser, and then retrieves all of the anchor tags and prints out the `href` attribute for each tag.

When the program is run it looks as follows:

```
python urllinks.py
Enter - http://www.dr-chuck.com/page1.htm
http://www.dr-chuck.com/page2.htm

python urllinks.py
Enter - http://www.py4inf.com/
http://www.greenteapress.com/thinkpython/thinkpython.html
http://allendowney.com/
http://www.si502.com/
http://www.lib.umich.edu/espresso-book-machine
http://www.py4inf.com/code
http://www.pythonlearn.com/
```

You can use `BeautifulSoup` to pull out various parts of each tag as follows:

```
import urllib
from BeautifulSoup import *
```

```
url = raw_input('Enter - ')
html = urllib.urlopen(url).read
soup = BeautifulSoup(html)

# Retrieve all of the anchor tags
tags = soup('a')
for tag in tags:
    # Look at the parts of a tag
    print 'TAG:',tag
    print 'URL:',tag.get('href', None)
    print 'Content:',tag.contents[0]
    print 'Attrs:',tag.attrs
```

This produces the following output:

```
python urllink2.py
Enter - http://www.dr-chuck.com/page1.htm
TAG: <a href="http://www.dr-chuck.com/page2.htm">
Second Page</a>
URL: http://www.dr-chuck.com/page2.htm
Content: [u'\nSecond Page']
Attrs: [(u'href', u'http://www.dr-chuck.com/page2.htm')]
```

These examples only begin to show the power of BeautifulSoup when it comes to parsing HTML. See the documentation and samples at w.crummy.com for more detail.

12.5 Glossary

BeautifulSoup: A Python library for parsing HTML documents and extracting data from HTML documents that compensates for most of the imperfections in the HTML that browsers generally ignore.

port: A number that generally indicates which application you are contacting when you make a socket connection to a server. As an example, web traffic usually uses port 80 while e-mail traffic uses port 50.

scrape: When a program pretends to be a web browser and retrieves a web page and then looks at the web page content. Often programs are following the links in one page to find the next page so they can traverse a network of pages or a social network.

socket: A network connection between two applications where the applications can send and receive data in either direction.

spider: The act of a web search engine retrieving a page and then all the pages linked from a page and so on until they have nearly all of the pages on the Internet which they use to build their search index.

12.6 Exercises

Exercise 12.1

Chapter 13

Using Web Services

Once it became easy to retrieve documents and parse documents over HTTP using programs, it did not take long to develop an approach where we started producing documents that were specifically designed to be consumed by other programs (i.e. not HTML to be displayed in a browser).

The most common approach when two programs are exchanging data across the web is to exchange the data in a format called the “eXtensible Markup Language” or XML.

13.1 eXtensible Markup Language - XML

XML looks very similar to HTML, but XML is more structured than HTML. Here is a sample of an XML document:

```
<person>
  <name>Chuck</name>
  <phone type="intl">
    +1 734 303 4456
  </phone>
  <email hide="yes"/>
</person>
```

13.2 Parsing XML

Here is a simple application that parses some XML and extracts some data elements from the XML:

```
import xml.etree.ElementTree as ET
```

```
data = '''
<person>
  <name>Chuck</name>
  <phone type="intl">
    +1 734 303 4456
  </phone>
  <email hide="yes"/>
</person>'''

tree = ET.fromstring(data)
print 'Name:', tree.find('name').text
print 'Attr:', tree.find('email').get('hide')
```

Calling `fromstring` converts the string representation of the XML into a 'tree' of XML nodes. When the XML is in a tree, we have a series of methods which we can call to extract portions of data from the XML.

The `find` function searches through the XML tree and retrieves a **node** that matches the specified tag. Each node can have some text, some attributes (i.e. like `hide`) and some "child" nodes. Each node can be the top of a tree of nodes.

```
Name: Chuck
Attr: yes
```

Using an XML parser such as `ElementTree` has the advantage that while the XML in this example is quite simple, it turns out that there are many rules regarding valid XML and using `ElementTree` allows us to extract data from XML without worrying about the rules of XML syntax.

13.3 Looping through nodes

Often the XML has multiple nodes and we need to write a loop to process all of the nodes. In the following program, we loop through all of the user nodes:

```
import xml.etree.ElementTree as ET

input = '''
<stuff>
  <users>
    <user x="2">
      <id>001</id>
      <name>Chuck</name>
    </user>
    <user x="7">
      <id>009</id>
      <name>Brent</name>
```

```
        </user>
    </users>
</stuff>'''

stuff = ET.fromstring(input)
lst = stuff.findall('users/user')
print 'User count:', len(lst)

for item in lst:
    print 'Name', item.find('name').text
    print 'Id', item.find('id').text
    print 'Attribute', item.get('x')
```

The `findall` method retrieves a Python list of sub-trees that represent the user structures in the XML tree. Then we can write a `for` loop that looks at each of the user nodes, and prints the name and id text elements as well as the x attribute from the user node.

```
User count: 2
Name Chuck
Id 001
Attribute 2
Name Brent
Id 009
Attribute 7
```

13.4 Application Programming Interfaces (API)

We now have the ability to exchange data between applications using HyperText Transport Protocol (HTTP) and a way to represent complex data that we are sending back and forth between these applications using eXtensible Markup Language (XML).

The next step is to begin to define and document “contracts” between applications using these techniques. The general name for these application-to-application contracts is **Application Program Interfaces** or APIs. When we use an API, generally one program makes a set of **services** available for use by other applications and publishes the APIs (i.e. the “rules”) which must be followed to access the services provided by the program.

When we begin to build our programs where the functionality of our program includes access to services provided by other programs, we call the approach a **Service-Oriented Architecture** or SOA. A SOA approach is one where our overall application makes use of the services of other applications. A non-SOA approach is where the application is a single stand-alone application which contains all of the code necessary to implement the application.

We see many examples of SOA when we use the web. We can go to a single web site and book air travel, hotels, and automobiles all from a single site. The data for hotels is not stored on the airline computers. Instead, the airline computers contact the services on the

hotel computers and retrieve the hotel data and present it to the user. When the user agrees to make a hotel reservation using the airline site, the airline site uses another web service on the hotel systems to actually make the reservation. And when it comes to charge your credit card for the whole transaction, still other computers become involved in the process.

A Service-Oriented Architecture has many advantages including: (1) we always maintain only one copy of data - this is particularly important for things like hotel reservations where we do not want to over-commit and (2) the owners of the data can set the rules about the use of their data. With these advantages, a SOA system must be carefully designed to have good performance and meet the user's needs.

When an application makes a set of services in its API available over the web, we call these **web services**.

13.5 Twitter web services

You are probably familiar with the Twitter web site and its applications <http://www.twitter.com>. Twitter has a very unique approach to its API/web services in that all of its data is available to non-Twitter applications using the Twitter API.

Because Twitter has been so liberal in allowing access to its data, it has enabled thousands of software developers to build their own customized Twitter-based software. These additional applications greatly increase the value of Twitter far beyond simply a web site. The Twitter web services allow the building of whole new applications that the Twitter team may never have thought of. It is said that over 90 percent of the use of Twitter is through the API (i.e. not through the [twitter.com](http://www.twitter.com) web user interface).

You can view the Twitter API documentation at <http://apiwiki.twitter.com/>. The Twitter API is an example of the REST style of web services. We will focus on the Twitter API to retrieve a list of a user's friends and their statuses. As an example, you can visit the following URL:

```
http://api.twitter.com/1/statuses/friends/drchuck.xml
```

To see a list of the friends of the twitter account drchuck. It may look like a mess in your browser. To see the actual XML returned by Twitter, you can view the source of the returned "web page".

We can retrieve this same XML using Python using the `urllib` utility:

```
import urllib

TWITTER_URL = 'http://api.twitter.com/1/statuses/friends/ACCT.xml'

while True:
    print ''
    acct = raw_input('Enter Twitter Account:')
    if ( len(acct) < 1 ) : break
```

```

url = TWITTER_URL.replace('ACCT', acct)
print 'Retrieving', url
document = urllib.urlopen (url).read()
print document[:250]

```

The program prompts for a Twitter account and opens the URL for the friends and statuses API and then retrieves the text from the URL and shows us the first 250 characters of the text.

```
python twitter1.py
```

```

Enter Twitter Account:drchuck
Retrieving http://api.twitter.com/1/statuses/friends/drchuck.xml
<?xml version="1.0" encoding="UTF-8"?>
<users type="array">
<user>
  <id>115636613</id>
  <name>Steve Coppin</name>
  <screen_name>steve_coppin</screen_name>
  <location>Kent, UK</location>
  <description>Software developing, best practicing, agile e

```

```
Enter Twitter Account:
```

In this application, we have retrieved the XML exactly as if it were an HTML web page. If we wanted to extract data from the XML, we could use Python string functions but this would become pretty complex as we tried to really start to dig into the XML in detail.

If we were to dump out some of the retrieved XML it would look roughly as follows:

```

<?xml version="1.0" encoding="UTF-8"?>
<users type="array">
  <user>
    <id>115636613</id>
    <name>Steve Coppin</name>
    <screen_name>steve_coppin</screen_name>
    <location>Kent, UK</location>
    <status>
      <id>10174607039</id>
      <source>web</source>
    </status>
  </user>
  <user>
    <id>17428929</id>
    <name>davidkocher</name>
    <screen_name>davidkocher</screen_name>
    <location>Bern</location>
    <status>

```

```

    <id>10306231257</id>
    <text>@MikeGrace If possible please post a detailed bug report </text>
  </status>
</user>
...

```

The top level tag is a users and there are multiple user tags below within the users tag. There is also a status tag below the user tag.

13.6 Handling XML data from an API

When we receive well-formed XML data from an API, we generally use an XML parser such as `ElementTree` to extract information from the XML data.

In the program below, we retrieve the friends and statuses from the Twitter API and then parse the returned XML to show the first four friends and their statuses.

```

import urllib
import xml.etree.ElementTree as ET

TWITTER_URL = 'http://api.twitter.com/1/statuses/friends/ACCT.xml'

while True:
    print ''
    acct = raw_input('Enter Twitter Account:')
    if ( len(acct) < 1 ) : break
    url = TWITTER_URL.replace('ACCT', acct)
    print 'Retrieving', url
    document = urllib.urlopen (url).read()
    print 'Retrieved', len(document), 'characters.'
    tree = ET.fromstring(document)
    count = 0
    for user in tree.findall('user'):
        count = count + 1
        if count > 4 : break
        print user.find('screen_name').text
        status = user.find('status')
        if status :
            txt = status.find('text').text
            print ' ',txt[:50]

```

We use the `findall` method to get a list of the user nodes and loop through the list using a `for` loop. For each user node, we pull out the text of the `screen_name` node and then pull out the status node. If there is a status node, we pull out the text of the `text` node and print the first 50 characters of the status text.

The pattern is pretty straightforward, we use `findall` and `find` to pull out a list of nodes or a single node and then if a node is a complex element with more sub-nodes we look deeper into the node until we reach the text element that we are interested in.

The program runs as follows:

```
python twitter2.py
```

```
Enter Twitter Account:drchuck
Retrieving http://api.twitter.com/1/statuses/friends/drchuck.xml
Retrieved 193310 characters.
steve_coppin
    Looking forward to some "oh no the markets closed,
davidkocher
    @MikeGrace If possible please post a detailed bug
hrheingold
    From today's Columbia Journalism Review, on crap d
huge_idea
    @drchuck #cnx2010 misses you, too. Thanks for co

Enter Twitter Account:hrheingold
Retrieving http://api.twitter.com/1/statuses/friends/hrheingold.xml
Retrieved 208081 characters.
carr2n
    RT @tysone: Saturday's proclamation by @carr2n pr
tiffanyshlain
    RT @ScottKirsner: Turning smartphones into a tool
soniasimone
    @ACCompanyC Funny, smart, cute, and also nice! He
JenStone7617
    Watching "Changing The Equation: High Tech Answers

Enter Twitter Account:
```

While the code for parsing the XML and extracting the fields using `ElementTree` takes a few lines to express what we are looking for in the XML, it is much simpler than trying to use Python string parsing to pull apart the XML and find the data elements.

13.7 Glossary

API: Application Program Interface - A contract between applications that defines the patterns of interaction between two application components.

ElementTree: A built-in Python library used to parse XML data.

REST: REpresentational State Transfer - A style of Web Services that provide access to resources within an application using the HTTP protocol.

SOA: Service Oriented Architecture - when an application is made of components connected across a network.

XML: eXtensible Markup Language - A format that allows for the markup of structured data.

13.8 Exercises

Exercise 13.1 Change the program that retrieves twitter data to also print out the location for each of the friends indented under the name by two spaces as follows:

```
Enter Twitter Account:drchuck
Retrieving http://api.twitter.com/1/statuses/friends/drchuck.xml
Retrieved 194533 characters.
steve_coppin
  Kent, UK
  Looking forward to some "oh no the markets closed,
davidkocher
  Bern
  @MikeGrace If possible please post a detailed bug
hrheingold
  San Francisco Bay Area
  RT @barrywellman: Lovely AmBerhSci Internet & Comm
huge_idea
  Boston, MA
  @drchuck #cnx2010 misses you, too. Thanks for co
```

Chapter 14

Using databases and Structured Query Language (SQL)

14.1 What is a database?

A **database** is a file that is organized for storing data. Most databases are organized like a dictionary in the sense that they map from keys to values. The biggest difference is that the database is on disk (or other permanent storage), so it persists after the program ends. Because a database is stored on permanent storage, it can store far more data than a dictionary, which is limited to the size of the memory in the computer.

Like a dictionary, database software is designed to keep the inserting and accessing of data very fast, even for large amounts of data. Database software maintains its performance by building **indexes** as data is added to the database to allow the computer to jump quickly to a particular entry.

There are many different database systems which are used for a wide variety of purposes including: Oracle, MySQL, Microsoft SQL Server, PostgreSQL, and SQLite. We focus on SQLite in this book because it is a very common database and is already built into Python. SQLite is designed to be *embedded* into other applications to provide database support within the application. For example, the Firefox browser also uses the SQLite database internally as do many other products.

<http://sqlite.org/>

SQLite is well suited to some of the data manipulation problems that we see in Informatics such as the Twitter spidering application that we describe in this chapter.

14.2 Database concepts

When you first look at a database it looks like a spreadsheet with multiple sheets. The primary data structures in a database are: **tables**, **rows**, and **columns**. In technical descriptions

of relational databases the concepts of table, row, and column are more formally referred to as **relation**, **tuple**, and **attribute**, respectively. We will use the less formal terms in this chapter.

14.3 SQLite Database Browser

While this chapter will focus on using Python to work with data in SQLite database files, many operations can be done more conveniently using a desktop program called the **SQLite Database Browser** which is freely available from:

<http://sourceforge.net/projects/sqlitebrowser/>

Using the browser you can easily create tables, insert data, edit data, or run simple SQL queries on the data in the database.

In a sense, the database browser is similar to a text editor when working with text files. When you want to do one or very few operations on a text file, you can just open it in a text editor and make the changes you want. When you have many changes that you need to do to a text file, often you will write a simple Python program. You will find the same pattern when working with databases. You will do simple operations in the database browser and more complex operations will be most conveniently done in Python.

14.4 Creating a database table

Databases require more defined structure than Python lists or dictionaries¹.

When we create a database **table** we must tell the database in advance the names of each of the **columns** in the table and the type of data which we are planning to store in each **column**. When the database software knows the type of data in each column, it can choose the most efficient way to store and lookup the data based on the type of data.

You can look at the various data types supported by SQLite at the following url:

<http://www.sqlite.org/datatypes.html>

Defining structure for your data up front may seem inconvenient at the beginning, but the payoff is fast access to your data even when the database contains a large amount of data.

The code to create a database file and a table named Tracks with two columns in the database is as follows:

```
import sqlite3

conn = sqlite3.connect('music.db')
cur = conn.cursor()
```

¹SQLite actually does allow some flexibility in the type of data stored in a column, but we will keep our data types strict in this chapter so the concepts apply equally to other database systems such as MySQL.

```
cur.execute('DROP TABLE IF EXISTS Tracks ')
cur.execute('CREATE TABLE Tracks (title TEXT, plays INTEGER)')

conn.close()
```

The connect operation makes a “connection” to the database stored in the file `music.db` in the current directory. If the file does not exist, it will be created. The reason this is called a “connection” is that sometimes the database is stored on a separate “database server” from the server on which we are running our application. In our simple examples the database will just be a local file in the same directory as the Python code we are running.

A **cursor** is like a file handle that we can use to perform operations on the data stored in the database. Calling `cursor()` is very similar conceptually to calling `open()` when dealing with text files.

Once we have the cursor, we can begin to execute commands on the contents of the database using the `execute()` method.

Database commands are expressed in a special language that has been standardized across many different database vendors to allow us to learn a single database language. The database language is called **Structured Query Language** or **SQL** for short.

<http://en.wikipedia.org/wiki/SQL>

In our example, we are executing two SQL commands in our database. As a convention, we will show the SQL keywords in uppercase and the parts of the command that we are adding (such as the table and column names) will be shown in lowercase.

The first SQL command removes the `Tracks` table from the database if it exists. This pattern is simply to allow us to run the same program to create the `Tracks` table over and over again without causing an error. Note that the `DROP TABLE` command deletes the table and all of its contents from the database (i.e. there is no “undo”).

```
cur.execute('DROP TABLE IF EXISTS Tracks ')
```

The second command creates a table named `Tracks` with a text column named `title` and an integer column named `plays`.

```
cur.execute('CREATE TABLE Tracks (title TEXT, plays INTEGER)')
```

Now that we have created a table named `Tracks`, we can put some data into that table using the SQL `INSERT` operation. Again, we begin by making a connection to the database and obtaining the cursor. We can then execute SQL commands using the cursor.

The SQL `INSERT` command indicates which table we are using and then defines a new row by listing the fields we want to include (`title`, `plays`) followed by the `VALUES` we want placed in the new row in the table. We specify the values as question marks (`?`, `?`) to indicate that the actual values are passed in as a tuple (`'My Way'`, `15`) as the second parameter to the `execute()` call.

```
import sqlite3

conn = sqlite3.connect('music.db')
cur = conn.cursor()

cur.execute('INSERT INTO Tracks (title, plays) VALUES ( ?, ? )',
            ( 'Thunderstruck', 20 ) )
cur.execute('INSERT INTO Tracks (title, plays) VALUES ( ?, ? )',
            ( 'My Way', 15 ) )
conn.commit()

print 'Tracks:'
cur.execute('SELECT title, plays FROM Tracks')
for row in cur :
    print row

cur.execute('DELETE FROM Tracks WHERE plays < 100')
conn.commit()

cur.close()
```

After we INSERT two rows into our table and use `commit()` to force the data to be written to the database file, we use the SELECT command to retrieve the rows we just inserted from the table. On the SELECT command, we indicate which columns we would like (`title`, `plays`) and indicate which table we want to retrieve the data from. After we execute the SELECT statement, the cursor is something we can loop through in a `for` statement. For efficiency, the cursor does not read all of the data from the database when we execute the SELECT statement. Instead, the data is read on-demand as we loop through the rows in the `for` statement.

The output of the program is as follows:

```
Tracks:
(u'Thunderstruck', 20)
(u'My Way', 15)
```

Our `for` loop finds two rows, and each row is a Python tuple with the first value as the `title` and the second value as the number of `plays`. Do not be concerned that the title strings are shown starting with `u'`. This is an indication that the strings are **Unicode** strings that are capable of storing non-Latin character sets.

At the very end of the program, we execute an SQL command to DELETE the rows we have just created so we can run the program over and over. The DELETE command shows the use of a WHERE clause that allows us to express a selection criterion so that we can ask the database to apply the command to only the rows that match the criterion. In this example the criterion happens to apply to all the rows so we empty the table out so we can run the program repeatedly. After the DELETE is performed we also call `commit()` to force the data to be removed from the database.

14.5 Structured Query Language (SQL) summary

So far, we have been using the Structured Query Language in our Python examples and have covered many of the basics of the SQL commands. In this section, we look at the SQL language in particular and give an overview of SQL syntax.

Since there are so many different database vendors, the Structured Query Language (SQL) was standardized so we could communicate in a portable manner to database systems from multiple vendors.

A relational database is made up of tables, rows, and columns. The columns generally have a type such as text, numeric, or date data. When we create a table, we indicate the names and types of the columns:

```
CREATE TABLE Tracks (title TEXT, plays INTEGER)
```

To insert a row into a table, we use the SQL INSERT command:

```
INSERT INTO Tracks (title, plays) VALUES ('My Way', 15)
```

The INSERT statement specifies the table name, and then a list of the fields/columns that you would like to set in the new row, and then the keyword VALUES and then a list of corresponding values for each of the fields.

The SQL SELECT command is used to retrieve rows and columns from a database. The SELECT statement lets you specify which columns you would like to retrieve as well as a WHERE clause to select which rows you would like to see. It also allows an optional ORDER BY clause to control the sorting of the returned rows.

```
SELECT * FROM Tracks WHERE title = 'My Way'
```

Using * indicates that you want the database to return all of the columns for each row that matches the WHERE clause.

Note, unlike in Python, in a SQL WHERE clause we use a single equal sign to indicate a test for equality rather than a double equal sign. Other logical operations allowed in a WHERE clause include <, >, <=, >=, !=, as well as AND and OR and parentheses to build your logical expressions.

You can request that the returned rows be sorted by one of the fields as follows:

```
SELECT title,plays FROM Tracks ORDER BY title
```

To remove a row, you need a WHERE clause on an SQL DELETE statement. The WHERE clause determines which rows are to be deleted:

```
DELETE FROM Tracks WHERE title = 'My Way'
```

It is possible to UPDATE a column or columns within one or more rows in a table using the SQL UPDATE statement as follows:

```
UPDATE Tracks SET plays = 16 WHERE title = 'My Way'
```

The UPDATE statement specifies a table and then a list of fields and values to change after the SET keyword and then an optional WHERE clause to select the rows that are to be updated. A single UPDATE statement will change all of the rows that match the WHERE clause, or if a WHERE clause is not specified, it performs the UPDATE on all of the rows in the table.

These four basic SQL commands (INSERT, SELECT, UPDATE, and DELETE) allow the four basic operations needed to create and maintain data.

14.6 Spidering Twitter using a database

In this section, we will create a simple spidering program that will go through Twitter accounts and build a database of them. *Note: Be very careful when running this program. You do not want to pull too much data or run the program for too long and end up having your Twitter access shut off.*

One of the problems of any kind of spidering program is that it needs to be able to be stopped and restarted many times and you do not want to lose the data that you have retrieved so far. You don't want to always restart your data retrieval at the very beginning so we want to store data as we retrieve it so our program can start back up and pick up where it left off.

We will start by retrieving one person's Twitter friends and their statuses, looping through the list of friends, and adding each of the friends to a database to be retrieved in the future. After we process one person's Twitter friends, we check in our database and retrieve one of the friends of the friend. We do this over and over, picking an "unvisited" person, retrieving their friend list and adding friends we have not seen to our list for a future visit.

We also track how many times we have seen a particular friend in the database to get some sense of "popularity".

By storing our list of known accounts and whether we have retrieved the account or not, and how popular the account is in a database on the disk of the computer, we can stop and restart our program as many times as we like.

This program is a bit complex. It is based on the code from the exercise earlier in the book that uses the Twitter API.

Here is the source code for our Twitter spidering application:

```
import sqlite3
import urllib
import xml.etree.ElementTree as ET

TWITTER_URL = 'http://api.twitter.com/1/statuses/friends/ACCT.xml'

conn = sqlite3.connect('twdata.db')
cur = conn.cursor()
```



```

cur.execute('''
CREATE TABLE IF NOT EXISTS
Twitter (name TEXT, retrieved INTEGER, friends INTEGER)''')

while True:
    acct = raw_input('Enter a Twitter account, or quit: ')
    if ( acct == 'quit' ) : break
    if ( len(acct) < 1 ) :
        cur.execute('SELECT name FROM Twitter WHERE retrieved = 0 LIMIT 1')
        try:
            acct = cur.fetchone()[0]
        except:
            print 'No unretrieved Twitter accounts found'
            continue

    url = TWITTER_URL.replace('ACCT', acct)
    print 'Retrieving', url
    document = urllib.urlopen (url).read()
    tree = ET.fromstring(document)

    cur.execute('UPDATE Twitter SET retrieved=1 WHERE name = ?', (acct, ) )

    countnew = 0
    countold = 0
    for user in tree.findall('user'):
        friend = user.find('screen_name').text
        cur.execute('SELECT friends FROM Twitter WHERE name = ? LIMIT 1',
            (friend, ) )
        try:
            count = cur.fetchone()[0]
            cur.execute('UPDATE Twitter SET friends = ? WHERE name = ?',
                (count+1, friend) )
            countold = countold + 1
        except:
            cur.execute('''INSERT INTO Twitter (name, retrieved, friends)
                VALUES ( ?, 0, 1 )''', ( friend, ) )
            countnew = countnew + 1
    print 'New accounts=',countnew,' revisited=',countold
    conn.commit()

cur.close()

```

Our database is stored in the file `twdata.db` and it has one table named `Twitter` and each row in the `Twitter` table has a column for the account name, whether we have retrieved the friends of this account, and how many times this account has been “friended”.

In the main loop of the program, we prompt the user for a Twitter account name or “quit”

to exit the program. If the user enters a Twitter account, we retrieve the list of friends and statuses for that user and add each friend to the database if not already in the database. If the friend is already in the list, we add one to the `friends` field in the row in the database.

If the user presses enter, we look in the database for the next Twitter account that we have not yet retrieved and retrieve the friends and statuses for that account, add them to the database or update them and increase their `friends` count.

Once we retrieve the list of friends and statuses, we loop through all of the user items in the returned XML and retrieve the `screen_name` for each user. Then we use the `SELECT` statement to see if we already have stored this particular `screen_name` in the database and retrieve the friend count (`friends`) if the record exists.

```
countnew = 0
countold = 0
for user in tree.findall('user'):
    friend = user.find('screen_name').text
    cur.execute('SELECT friends FROM Twitter WHERE name = ? LIMIT 1',
                (friend, ) )
    try:
        count = cur.fetchone()[0]
        cur.execute('UPDATE Twitter SET friends = ? WHERE name = ?',
                    (count+1, friend) )
        countold = countold + 1
    except:
        cur.execute('INSERT INTO Twitter (name, retrieved, friends)
                    VALUES ( ?, 0, 1 )', ( friend, ) )
        countnew = countnew + 1
print 'New accounts=',countnew,' revisited=',countold
conn.commit()
```

Once the cursor executes the `SELECT` statement, we must retrieve the rows. We could do this with a `for` statement, but since we are only retrieving one row (`LIMIT 1`), we can use the `fetchone()` method to fetch the first (and only) row that is the result of the `SELECT` operation. Since `fetchone()` returns the row as a **tuple** (even though there is only one field), we take the first value from the tuple using `[0]` to get the current friend count into the variable `count`.

If this retrieval is successful, we use the `SQL UPDATE` statement with a `WHERE` clause to add one to the `friends` column for the row that matches the friend's account. Notice that there are two placeholders (i.e. question marks) in the `SQL`, and the second parameter to the `execute()` is a two-element tuple which holds the values to be substituted into the `SQL` in place of the question marks.

If the code in the `try` block fails it is probably because no record matched the `WHERE name = ?` clause on the `SELECT` statement. So in the `except` block, we use the `SQL INSERT` statement to add the friend's `screen_name` to the table with an indication that we have not yet retrieved the `screen_name` and setting the friend count to zero.

So the first time the program runs and we enter a Twitter account, the program runs as follows:

```
Enter a Twitter account, or quit: drchuck
Retrieving http://api.twitter.com/1/statuses/friends/drchuck.xml
New accounts= 100 revisited= 0
Enter a Twitter account, or quit: quit
```

Since this is the first time we have run the program, the database is empty and we create the database in the file `twdata.db` and add a table named `Twitter` to the database. Then we retrieve some friends and add them all to the database since the database is empty.

At this point, we might want to write a simple database dumper to take a look at what is in our `twdata.db` file:

```
import sqlite3

conn = sqlite3.connect('twdata.db')
cur = conn.cursor()
cur.execute('SELECT * FROM Twitter')
count = 0
for row in cur :
    print row
    count = count + 1
print count, 'rows.'
cur.close()
```

This program simply opens the database and selects all of the columns of all of the rows in the table `Twitter`, then loops through the rows and prints out each row.

If we run this program after the first execution of our Twitter spider above, its output will be as follows:

```
(u'opencontent', 0, 1)
(u'lhawthorn', 0, 1)
(u'steve_coppin', 0, 1)
(u'davidkocher', 0, 1)
(u'hrheingold', 0, 1)
...
100 rows.
```

We see one row for each `screen_name`, that we have not retrieved the data for that `screen_name` and everyone in the database has one friend.

Now our database reflects the retrieval of the friends of our first Twitter account (**drchuck**). We can run the program again and tell it to retrieve the friends of the next “unprocessed” account by simply pressing enter instead of a Twitter account as follows:

```

Enter a Twitter account, or quit:
Retrieving http://api.twitter.com/1/statuses/friends/opencontent.xml
New accounts= 98  revisited= 2
Enter a Twitter account, or quit:
Retrieving http://api.twitter.com/1/statuses/friends/lhawthorn.xml
New accounts= 97  revisited= 3
Enter a Twitter account, or quit: quit

```

Since we pressed enter (i.e. we did not specify a Twitter account), the following code is executed:

```

if ( len(acct) < 1 ) :
    cur.execute('SELECT name FROM Twitter WHERE retrieved = 0 LIMIT 1')
    try:
        acct = cur.fetchone()[0]
    except:
        print 'No unretrieved twitter accounts found'
        continue

```

We use the SQL `SELECT` statement to retrieve the name of the first (`LIMIT 1`) user who still has their “have we retrieved this user” value set to zero. We also use the `fetchone()[0]` pattern within a `try/except` block to either extract a `screen_name` from the retrieved data or put out an error message and loop back up.

If we successfully retrieved an unprocessed `screen_name`, we retrieve their data as follows:

```

url = TWITTER_URL.replace('ACCT', acct)
print 'Retrieving', url
document = urllib.urlopen (url).read()
tree = ET.fromstring(document)

cur.execute('UPDATE Twitter SET retrieved=1 WHERE name = ?', (acct, ))

```

Once we retrieve the data successfully, we use the `UPDATE` statement to set the `retrieved` column to one to indicate that we have completed the retrieval of the friends of this account. This keeps us from re-retrieving the same data over and over and keeps us progressing forward through the network of Twitter friends.

If we run the friend program and press enter twice to retrieve the next unvisited friend’s friends, then run the dumping program, it will give us the following output:

```

(u'opencontent', 1, 1)
(u'lhawthorn', 1, 1)
(u'steve_coppin', 0, 1)
(u'davidkocher', 0, 1)
(u'hrheingold', 0, 1)
...
(u'cnxorg', 0, 2)

```

```
(u'knoop', 0, 1)
(u'kthanos', 0, 2)
(u'LectureTools', 0, 1)
...
295 rows.
```

We can see that we have properly recorded that we have visited lhawthorn and opencontent. Also the accounts cnxorg and kthanos already have two followers. Since we now have retrieved the friends of three people (drchuck, opencontent and lhawthorn) our table has 295 rows of friends to retrieve.

Each time we run the program and press enter, it will pick the next unvisited account (e.g. the next account will be steve_coppin), retrieve their friends, mark them as retrieved and for each of the friends of steve_coppin, either add them to the end of the database, or update their friend count if they are already in the database.

Since the program's data is all stored on disk in a database, the spidering activity can be suspended and resumed as many times as you like with no loss of data.

Note: One more time before we leave this topic, be very careful when running this Twitter spidering program. You do not want to pull too much data or run the program for too long and end up having your Twitter access shut off.

14.7 Basic data modeling

The real power of a relational database is when we make multiple tables and make links between those tables. The act of deciding how to break up your application data into multiple tables and establishing the relationships between the two tables is called **data modeling**. The design document that shows the tables and their relationships is called a **data model**.

Data modeling is a relatively sophisticated skill and we will only introduce the most basic concepts of relational data modeling in this section. For more detail on data modeling you can start with:

http://en.wikipedia.org/wiki/Relational_model

Let's say for our Twitter spider application, instead of just counting a person's friends, we wanted to keep a list of all of the incoming relationships so we could find a list of everyone who is following a particular account.

Since everyone will potentially have many accounts that follow them, we cannot simply add a single column to our Twitter table. So we create a new table that keeps track of pairs of friends. The following is a simple way of making such a table:

```
CREATE TABLE Pals (from_friend TEXT, to_friend TEXT)
```

Each time we encounter a person who drchuck is following, we would insert a row of the form:

```
INSERT INTO Pals (from_friend,to_friend) VALUES ('drchuck', 'lhawthorn')
```

As we are processing the 100 friends from the drchuck Twitter feed, we will insert 100 records with “drchuck” as the first parameter so we will end up duplicating the string many times in the database.

This duplication of string data violates the best practices for **database normalization** which basically states that we should never put the same string data in the database more than once. If we need the data more than once, we create a numeric **key** for the data and reference the actual data using this key.

In practical terms, a string takes up a lot more space than an integer on the disk and in the memory of our computer and takes more processor time to compare and sort. If we only have a few hundred entries the storage and processor time hardly matters. But if we have a million people in our database and a possibility of 100 million friend links, it is important to be able to scan data as quickly as possible.

We will store our Twitter accounts in a table named `People` instead of the `Twitter` table used in the previous example. The `People` table has an additional column to store the numeric key associated with the row for this Twitter user. SQLite has a feature that automatically adds the key value for any row we insert into a table using a special type of data column (`INTEGER PRIMARY KEY`).

We can create the `People` table with this additional `id` column as follows:

```
CREATE TABLE People
  (id INTEGER PRIMARY KEY, name TEXT UNIQUE, retrieved INTEGER)
```

Notice that we are no longer maintaining a friend count in each row of the `People` table. When we select `INTEGER PRIMARY KEY` as the type of our `id` column, we are indicating that we would like SQLite to manage this column and assign a unique numeric key to each row we insert automatically. We also add the keyword `UNIQUE` to indicate that we will not allow SQLite to insert two rows with the same value for `name`.

Now instead of creating the table `Pals` above, we create a table called `Follows` with two integer columns `from_id` and `to_id` and a constraint on the table that the *combination* of `from_id` and `to_id` must be unique in this table (i.e. we cannot insert duplicate rows) in our database.

```
CREATE TABLE Follows
  (from_id INTEGER, to_id INTEGER, UNIQUE(from_id, to_id) )
```

As we add these `UNIQUE` clauses to our tables, we are communicating a set of rules that we are asking the database to enforce when we attempt to insert records. We are creating these rules as a convenience in our programs as we will see in a moment. The rules both keep us from making mistakes and make it simpler to write some of our code.

14.8 Programming with multiple tables

We will now re-do the Twitter spider program using two tables, the primary keys, and the key references as described above. Here is the code for the new version of the program:

```
import sqlite3
import urllib
import xml.etree.ElementTree as ET

TWITTER_URL = 'http://api.twitter.com/1/statuses/friends/ACCT.xml'

conn = sqlite3.connect('twdata.db')
cur = conn.cursor()

cur.execute('''CREATE TABLE IF NOT EXISTS People
              (id INTEGER PRIMARY KEY, name TEXT UNIQUE, retrieved INTEGER)''')
cur.execute('''CREATE TABLE IF NOT EXISTS Follows
              (from_id INTEGER, to_id INTEGER, UNIQUE(from_id, to_id))''')

while True:
    acct = raw_input('Enter a Twitter account, or quit: ')
    if ( acct == 'quit' ) : break
    if ( len(acct) < 1 ) :
        cur.execute('''SELECT id,name FROM People
                      WHERE retrieved = 0 LIMIT 1''')
        try:
            (id, acct) = cur.fetchone()
        except:
            print 'No unretrieved Twitter accounts found'
            continue
    else:
        cur.execute('SELECT id FROM People WHERE name = ? LIMIT 1',
                    (acct, ) )
        try:
            id = cur.fetchone()[0]
        except:
            cur.execute('''INSERT OR IGNORE INTO People
                          (name, retrieved) VALUES ( ?, 0)''', ( acct, ) )
            conn.commit()
            if cur.rowcount != 1 :
                print 'Error inserting account:',acct
                continue
            id = cur.lastrowid

    url = TWITTER_URL.replace('ACCT', acct)
    print 'Retrieving', url
    document = urllib.urlopen (url).read()
    tree = ET.fromstring(document)

    cur.execute('UPDATE People SET retrieved=1 WHERE name = ?', (acct, ) )
```

```

countnew = 0
countold = 0
for user in tree.findall('user'):
    friend = user.find('screen_name').text
    cur.execute('SELECT id FROM People WHERE name = ? LIMIT 1',
                (friend, ) )
    try:
        friend_id = cur.fetchone()[0]
        countold = countold + 1
    except:
        cur.execute(''INSERT OR IGNORE INTO People (name, retrieved)
                    VALUES ( ?, 0)''', ( friend, ) )
        conn.commit()
        if cur.rowcount != 1 :
            print 'Error inserting account:',friend
            continue
        friend_id = cur.lastrowid
        countnew = countnew + 1
    cur.execute(''INSERT OR IGNORE INTO Follows
                (from_id, to_id) VALUES (?, ?)''', (id, friend_id) )
print 'New accounts=',countnew,' revisited=',countold
conn.commit()

cur.close()

```

This program is starting to get a bit complicated, but it illustrates the patterns that we need to use when we are using integer keys to link tables. The basic patterns are:

1. Creating tables with primary keys and constraints.
2. When we have a logical key for a person (i.e. account name) and we need the id value for the person. Depending on whether or not the person is already in the People table, we either need to: (1) look up the person in the People table and retrieve the id value for the person or (2) add the person to the People table and get the id value for the newly added row.
3. Insert the row that captures the “follows” relationship.

We will cover each of these in turn.

14.8.1 Constraints in database tables

As we design our table structures, we can tell the database system that we would like it to enforce a few rules on us. These rules help us from making mistakes and introducing incorrect data into our tables. When we create our tables:

```
cur.execute('''CREATE TABLE IF NOT EXISTS People
              (id INTEGER PRIMARY KEY, name TEXT UNIQUE, retrieved INTEGER)''')
cur.execute('''CREATE TABLE IF NOT EXISTS Follows
              (from_id INTEGER, to_id INTEGER, UNIQUE(from_id, to_id))''')
```

We indicate that the name column in the People table must be UNIQUE. We also indicate that the combination of the two numbers in each row of the Follows table must be unique. These constraints keep us from making mistakes such as adding the same relationship more than once.

We can take advantage of these constraints in the following code:

```
cur.execute('''INSERT OR IGNORE INTO People (name, retrieved)
              VALUES ( ?, 0)''', ( friend, ) )
```

We add the OR IGNORE clause to our INSERT statement to indicate that if this particular INSERT would cause a violation of the “name must be unique” rule, the database system is allowed to ignore the INSERT. We are using the database constraint as a safety net to make sure we don’t inadvertently do something incorrect.

Similarly, the following code ensures that we don’t add the exact same Follows relationship twice.

```
cur.execute('''INSERT OR IGNORE INTO Follows
              (from_id, to_id) VALUES (?, ?)''', (id, friend_id) )
```

Again we simply tell the database to ignore our attempted INSERT if it would violate the uniqueness constraint that we specified for the Follows rows.

14.8.2 Retrieve and/or insert a record

When we prompt the user for a Twitter account, if the account exists, we must look up its id value. If the account does not yet exist in the People table, we must insert the record and get the id value from the inserted row.

This is a very common pattern and is done twice in the program above. This code shows how we look up the id for a friend’s account when we have extracted a screen_name from a user node in the retrieved Twitter XML.

Since over time it will be increasingly likely that the account will already be in the database, we first check to see if the People record exists using a SELECT statement.

If all goes well² inside the try section, we retrieve the record using fetchone() and then retrieve the first (and only) element of the returned tuple and store it in id.

If the SELECT fails, the fetchone()[0] code will fail and control will transfer into the except section.

²In general, when a sentence starts with “if all goes well” you will find that the code needs to use try/except.

```

friend = user.find('screen_name').text
cur.execute('SELECT id FROM People WHERE name = ? LIMIT 1',
            (friend, ) )
try:
    friend_id = cur.fetchone()[0]
    countold = countold + 1
except:
    cur.execute('''INSERT OR IGNORE INTO People (name, retrieved)
                VALUES ( ?, 0)''', ( friend, ) )
    conn.commit()
    if cur.rowcount != 1 :
        print 'Error inserting account:',friend
        continue
    friend_id = cur.lastrowid
    countnew = countnew + 1

```

If we end up in the except code, it simply means that the row was not found so we must insert the row. We use `INSERT OR IGNORE` just to avoid errors and then call `commit()` to force the database to really be updated. After the write is done, we can check the `cur.rowcount` to see how many rows were affected. Since we are attempting to insert a single row, if the number of affected rows is something other than one, it is an error.

If the `INSERT` is successful, we can look at `cur.lastrowid` to find out what value the database assigned to the `id` column in our newly created row.

14.8.3 Storing the friend relationship

Once we know the key value for both the Twitter user and the friend in the XML, it is a simple matter to insert the two numbers into the `Follows` table with the following code:

```

cur.execute('INSERT OR IGNORE INTO Follows (from_id, to_id) VALUES (?, ?)',
            (id, friend_id) )

```

Notice that we let the database take care of keeping us from “double-inserting” a relationship by creating the table with a uniqueness constraint and then adding `OR IGNORE` to our `INSERT` statement.

Here is a sample execution of this program:

```

Enter a Twitter account, or quit:
No unretrieved Twitter accounts found
Enter a Twitter account, or quit: drchuck
Retrieving http://api.twitter.com/1/statuses/friends/drchuck.xml
New accounts= 100 revisited= 0
Enter a Twitter account, or quit:
Retrieving http://api.twitter.com/1/statuses/friends/opencontent.xml
New accounts= 97 revisited= 3

```

```
Enter a Twitter account, or quit:
Retrieving http://api.twitter.com/1/statuses/friends/lhawthorn.xml
New accounts= 97  revisited= 3
Enter a Twitter account, or quit: quit
```

We started with the `drchuck` account and then let the program automatically pick the next two accounts to retrieve and add to our database.

The following is the first few rows in the `People` and `Follows` tables after this run is completed:

```
People:
(1, u'drchuck', 1)
(2, u'opencontent', 1)
(3, u'lhawthorn', 1)
(4, u'steve_coppin', 0)
(5, u'davidkocher', 0)
295 rows.
Follows:
(1, 2)
(1, 3)
(1, 4)
(1, 5)
(1, 6)
300 rows.
```

You can see the `id`, `name`, and `visited` fields in the `People` table and you see the numbers of both ends of the relationship `Follows` table. In the `People` table, we can see that the first three people have been visited and their data has been retrieved. The data in the `Follows` table indicates that `drchuck` (user 1) is a friend to all of the people shown in the first five rows. This makes sense because the first data we retrieved and stored was the Twitter friends of `drchuck`. If you were to print more rows from the `Follows` table, you would see the friends of user two and three as well.

14.9 Three kinds of keys

Now that we have started building a data model putting our data into multiple linked tables, and linking the rows in those tables using **keys**, we need to look at some terminology around keys. There are generally three kinds of keys used in a database model.

- A **logical key** is a key that the “real world” might use to look up a row. In our example data model, the `name` field is a logical key. It is the screen name for the user and we indeed look up a user’s row several times in the program using the `name` field. You will often find that it makes sense to add a `UNIQUE` constraint to a logical key. Since the logical key is how we look up a row from the outside world, it makes little sense to allow multiple rows with the same value in the table.

- A **primary key** is usually a number that is often assigned automatically by the database. It generally has no meaning outside the program and is only used to link rows from different tables together. When we want to look up a row in a table, usually searching for the row using the primary key is the fastest way to find a row. Since primary keys are integer numbers, they take up very little storage and can be compared or sorted very quickly. In our data model, the `id` field is an example of a primary key.
- A **foreign key** is usually a number that points to the primary key of an associated row in a different table. An example of a foreign key in our data model is the `from_id`.

We are using a naming convention of always calling the primary key field name `id` and appending the suffix `_id` to any field name that is a foreign key.

14.10 Using JOIN to retrieve data

Now that we have followed the rules of database normalization and have data separated into two tables, linked together using primary and foreign keys, we need to be able to build a `SELECT` that re-assembles the data across the tables.

SQL uses the `JOIN` clause to re-connect these tables. In the `JOIN` clause you specify the fields that are used to re-connect the rows between the tables.

The following is an example of a `SELECT` with a `JOIN` clause:

```
SELECT * FROM Follows JOIN People
  ON Follows.to_id = People.id WHERE Follows.from_id = 2
```

The `JOIN` clause indicates that the fields we are selecting cross both the `Follows` and `People` tables. The `ON` clause indicates how the two tables are to be joined. Take the rows from `Follows` and append the row from `People` where the field `from_id` in `Follows` is the same the `id` value in the `People` table.

The result of the `JOIN` is to create an extra-long “meta-row” which has both the fields from `Follows` and the matching fields from `People`.

The following code demonstrates the data that we will have in the database after the multi-table Twitter spider program (above) has been run several times.

```
import sqlite3

conn = sqlite3.connect('twdata.db')
cur = conn.cursor()

cur.execute('SELECT * FROM People')
count = 0
print 'People:'
for row in cur :
```

```
        if count < 5: print row
        count = count + 1
print count, 'rows.'

cur.execute('SELECT * FROM Follows')
count = 0
print 'Follows:'
for row in cur :
    if count < 5: print row
    count = count + 1
print count, 'rows.'

cur.execute('''SELECT * FROM Follows JOIN People
             ON Follows.to_id = People.id WHERE Follows.from_id = 2''')
count = 0
print 'Connections for id=2:'
for row in cur :
    if count < 5: print row
    count = count + 1
print count, 'rows.'

cur.close()
```

In this program, we first dump out the People and Follows and then dump out a subset of the data in the tables joined together.

Here is the output of the program:

```
python twjoin.py
People:
(1, u'drchuck', 1)
(2, u'opencontent', 1)
(3, u'lhawthorn', 1)
(4, u'steve_coppin', 0)
(5, u'davidkocher', 0)
295 rows.
Follows:
(1, 2)
(1, 3)
(1, 4)
(1, 5)
(1, 6)
300 rows.
Connections for id=2:
(2, 1, 1, u'drchuck', 1)
(2, 28, 28, u'cnxorg', 0)
(2, 30, 30, u'kthanos', 0)
```

```
(2, 102, 102, u'SomethingGirl', 0)
(2, 103, 103, u'ja_Pac', 0)
100 rows.
```

You see the columns from the `People` and `Follows` tables and the last set of rows is the result of the `SELECT` with the `JOIN` clause.

In the last select, we are looking for accounts that are friends of “opencontent” (i.e. `People.id=2`).

In each of the “meta-rows” in the last select, the first two columns are from the `Follows` table followed by columns three through five from the `People` table. You can also see that the second column (`Follows.to_id`) matches the third column (`People.id`) in each of the joined-up “meta-rows”.

14.11 Summary

This chapter has covered a lot of ground to give you an overview of the basics of using a database in Python. It is more complicated to write the code to use a database to store data than Python dictionaries or flat files so there is little reason to use a database unless your application truly needs the capabilities of a database. The situations where a database can be quite useful are: (1) when your application needs to make small many random updates within a large data set, (2) when your data is so large it cannot fit in a dictionary and you need to look up information repeatedly, or (3) you have a long-running process that you want to be able to stop and restart and retain the data from one run to the next.

You can build a simple database with a single table to suit many application needs, but most problems will require several tables and links/relationships between rows in different tables. When you start making links between tables, it is important to do some thoughtful design and follow the rules of database normalization to make the best use of the database’s capabilities. Since the primary motivation for using a database is that you have a large amount of data to deal with, it is important to model your data efficiently so your programs run as fast as possible.

14.12 Debugging

One common pattern when you are developing a Python program to connect to an SQLite database will be to run a Python program and check the results using the SQLite Database Browser. The browser allows you to quickly check to see if your program is working properly.

You must be careful because SQLite takes care to keep two programs from changing the same data at the same time. For example, if you open a database in the browser and make a change to the database and have not yet pressed the “save” button in the browser, the browser “locks” the database file and keeping any other program from accessing the file. In particular, your Python program will not be able to access the file if it is locked.

So a solution is to make sure to either close the database browser or use the **File** menu to close the database in the browser before you attempt to access the database from Python to avoid the problem of your Python code failing because the database is locked.

14.13 Glossary

attribute: One of the values within a tuple. More commonly called a “column” or “field”.

constraint: When we tell the database to enforce a rule on a field or a row in a table. A common constraint is to insist that there can be no duplicate values in a particular field (i.e. all the values must be unique).

cursor: A cursor allows you to execute SQL commands in a database and retrieve data from the database. A cursor is similar to a socket or file handle for network connections and files respectively.

database browser: A piece of software that allows you to directly connect to a database and manipulate the database directly without writing a program.

foreign key: A numeric key that points to the primary key of a row in another table. Foreign keys establish relationships between rows stored in different tables.

index: Additional data that the database software maintains as rows are inserted into a table designed to make lookups very fast.

logical key: A key that the “outside world” uses to look up a particular row. For example in a table of user accounts, a person’s E-Mail address might be a good candidate as the logical key for the user’s data.

normalization: Designing a data model so that no data is replicated. We store each item of data at one place in the database and reference it elsewhere using a foreign key.

primary key: A numeric key assigned to each row that is used to refer to one row in a table from another table. Often the database is configured to automatically assign primary keys as rows are inserted.

relation: An area within a database that contains tuples and attributes. More typically called a “table”.

tuple: A single entry in a database table that is a set of attributes. More typically called “row”.

Chapter 15

Advanced functions

15.1 Return values

Some of the built-in functions we have used, such as the math functions, produce results. Calling the function generates a value, which we usually assign to a variable or use as part of an expression.

```
e = math.exp(1.0)
height = radius * math.sin(radians)
```

All of the functions we have written so far are void; they print something or move turtles around, but their return value is None.

In this chapter, we are (finally) going to write fruitful functions. The first example is area, which returns the area of a circle with the given radius:

```
def area(radius):
    temp = math.pi * radius**2
    return temp
```

We have seen the return statement before, but in a fruitful function the return statement includes an expression. This statement means: “Return immediately from this function and use the following expression as a return value.” The expression can be arbitrarily complicated, so we could have written this function more concisely:

```
def area(radius):
    return math.pi * radius**2
```

On the other hand, **temporary variables** like temp often make debugging easier.

Sometimes it is useful to have multiple return statements, one in each branch of a conditional:

```
def absolute_value(x):
    if x < 0:
        return -x
    else:
        return x
```

Since these `return` statements are in an alternative conditional, only one will be executed.

As soon as a `return` statement executes, the function terminates without executing any subsequent statements. Code that appears after a `return` statement, or any other place the flow of execution can never reach, is called **dead code**.

In a fruitful function, it is a good idea to ensure that every possible path through the program hits a `return` statement. For example:

```
def absolute_value(x):
    if x < 0:
        return -x
    if x > 0:
        return x
```

This function is incorrect because if `x` happens to be 0, neither condition is true, and the function ends without hitting a `return` statement. If the flow of execution gets to the end of a function, the return value is `None`, which is not the absolute value of 0.

```
>>> print absolute_value(0)
None
```

By the way, Python provides a built-in function called `abs` that computes absolute values.

Exercise 15.1 Write a `compare` function that returns 1 if `x > y`, 0 if `x == y`, and -1 if `x < y`.

15.2 Tuples as return values

Strictly speaking, a function can only return one value, but if the value is a tuple, the effect is the same as returning multiple values. For example, if you want to divide two integers and compute the quotient and remainder, it is inefficient to compute `x/y` and then `x%y`. It is better to compute them both at the same time.

The built-in function `divmod` takes two arguments and returns a tuple of two values, the quotient and remainder. You can store the result as a tuple:

```
>>> t = divmod(7, 3)
>>> print t
(2, 1)
```

Or use tuple assignment to store the elements separately:

```
>>> quot, rem = divmod(7, 3)
>>> print quot
2
>>> print rem
1
```

Here is an example of a function that returns a tuple:

```
def min_max(t):
    return min(t), max(t)
```

`max` and `min` are built-in functions that find the largest and smallest elements of a sequence. `min_max` computes both and returns a tuple of two values.

15.3 Variable-length argument tuples

Functions can take a variable number of arguments. A parameter name that begins with ***** **gathers** arguments into a tuple. For example, `printall` takes any number of arguments and prints them:

```
def printall(*args):
    print args
```

The gather parameter can have any name you like, but `args` is conventional. Here's how the function works:

```
>>> printall(1, 2.0, '3')
(1, 2.0, '3')
```

You can combine the gather operator with required and positional arguments:

```
def pointless(required, optional=0, *args):
    print required, optional, args
```

Run this function with 1, 2, 3 and 4 or more arguments and make sure you understand what it does.

The complement of gather is **scatter**. If you have a sequence of values and you want to pass it to a function as multiple arguments, you can use the ***** operator. For example, `divmod` takes exactly two arguments; it doesn't work with a tuple:

```
>>> t = (7, 3)
>>> divmod(t)
TypeError: divmod expected 2 arguments, got 1
```

But if you scatter the tuple, it works:

```
>>> divmod(*t)
(2, 1)
```

Exercise 15.2 Many of the built-in functions use variable-length argument tuples. For example, `max` and `min` can take any number of arguments:

```
>>> max(1,2,3)
3
```

But `sum` does not.

```
>>> sum(1,2,3)
TypeError: sum expected at most 2 arguments, got 3
```

Write a function called `sumall` that takes any number of arguments and returns their sum.

15.4 Variables and parameters are local

When you create a variable inside a function, it is **local**, which means that it only exists inside the function. For example:

```
def cat_twice(part1, part2):
    cat = part1 + part2
    print_twice(cat)
```

This function takes two arguments, concatenates them, and prints the result twice. Here is an example that uses it:

```
>>> line1 = 'Bing tiddle '
>>> line2 = 'tiddle bang.'
>>> cat_twice(line1, line2)
Bing tiddle tiddle bang.
Bing tiddle tiddle bang.
```

When `cat_twice` terminates, the variable `cat` is destroyed. If we try to print it, we get an exception:

```
>>> print cat
NameError: name 'cat' is not defined
```

Parameters are also local. For example, outside `print_twice`, there is no such thing as `bruce`.

15.5 Global variables

In the previous example, `known` is created outside the function, so it belongs to the special frame called `__main__`. Variables in `__main__` are sometimes called **global** because they can be accessed from any function. Unlike local variables, which disappear when their function ends, global variables persist from one function call to the next.

It is common to use global variables for **flags**; that is, boolean variables that indicate (“flag”) whether a condition is true. For example, some programs use a flag named `verbose` to control the level of detail in the output:

```
verbose = True

def example1():
    if verbose:
        print 'Running example1'
```

If you try to reassign a global variable, you might be surprised. The following example is supposed to keep track of whether the function has been called:

```
been_called = False

def example2():
    been_called = True          # WRONG
```

But if you run it you will see that the value of `been_called` doesn’t change. The problem is that `example2` creates a new local variable named `been_called`. The local variable goes away when the function ends, and has no effect on the global variable.

To reassign a global variable inside a function you have to **declare** the global variable before you use it:

```
been_called = False

def example2():
    global been_called
    been_called = True
```

The `global` statement tells the interpreter something like, “In this function, when I say `been_called`, I mean the global variable; don’t create a local one.”

Here’s an example that tries to update a global variable:

```
count = 0

def example3():
    count = count + 1          # WRONG
```

If you run it you get:

```
UnboundLocalError: local variable 'count' referenced before assignment
```

Python assumes that `count` is local, which means that you are reading it before writing it. The solution, again, is to declare `count` global.

```
def example3():
    global count
    count += 1
```

If the global value is mutable, you can modify it without declaring it:

```
known = {0:0, 1:1}
```

```
def example4():  
    known[2] = 1
```

So you can add, remove and replace elements of a global list or dictionary, but if you want to reassign the variable, you have to declare it:

```
def example5():  
    global known  
    known = dict()
```

15.6 Incremental development

As you write larger functions, you might find yourself spending more time debugging.

To deal with increasingly complex programs, you might want to try a process called **incremental development**. The goal of incremental development is to avoid long debugging sessions by adding and testing only a small amount of code at a time.

As an example, suppose you want to find the distance between two points, given by the coordinates (x_1, y_1) and (x_2, y_2) . By the Pythagorean theorem, the distance is:

$$\text{distance} = \sqrt{(x_2 - x_1)^2 + (y_2 - y_1)^2}$$

The first step is to consider what a distance function should look like in Python. In other words, what are the inputs (parameters) and what is the output (return value)?

In this case, the inputs are two points, which you can represent using four numbers. The return value is the distance, which is a floating-point value.

Already you can write an outline of the function:

```
def distance(x1, y1, x2, y2):  
    return 0.0
```

Obviously, this version doesn't compute distances; it always returns zero. But it is syntactically correct, and it runs, which means that you can test it before you make it more complicated.

To test the new function, call it with sample arguments:

```
>>> distance(1, 2, 4, 6)  
0.0
```

I chose these values so that the horizontal distance is 3 and the vertical distance is 4; that way, the result is 5 (the hypotenuse of a 3-4-5 triangle). When testing a function, it is useful to know the right answer.

At this point we have confirmed that the function is syntactically correct, and we can start adding code to the body. A reasonable next step is to find the differences $x_2 - x_1$ and $y_2 - y_1$. The next version stores those values in temporary variables and prints them.

```
def distance(x1, y1, x2, y2):
    dx = x2 - x1
    dy = y2 - y1
    print 'dx is', dx
    print 'dy is', dy
    return 0.0
```

If the function is working, it should display 'dx is 3' and 'dy is 4'. If so, we know that the function is getting the right arguments and performing the first computation correctly. If not, there are only a few lines to check.

Next we compute the sum of squares of dx and dy:

```
def distance(x1, y1, x2, y2):
    dx = x2 - x1
    dy = y2 - y1
    dsquared = dx**2 + dy**2
    print 'dsquared is: ', dsquared
    return 0.0
```

Again, you would run the program at this stage and check the output (which should be 25). Finally, you can use `math.sqrt` to compute and return the result:

```
def distance(x1, y1, x2, y2):
    dx = x2 - x1
    dy = y2 - y1
    dsquared = dx**2 + dy**2
    result = math.sqrt(dsquared)
    return result
```

If that works correctly, you are done. Otherwise, you might want to print the value of `result` before the return statement.

The final version of the function doesn't display anything when it runs; it only returns a value. The `print` statements we wrote are useful for debugging, but once you get the function working, you should remove them. Code like that is called **scaffolding** because it is helpful for building the program but is not part of the final product.

When you start out, you should add only a line or two of code at a time. As you gain more experience, you might find yourself writing and debugging bigger chunks. Either way, incremental development can save you a lot of debugging time.

The key aspects of the process are:

1. Start with a working program and make small incremental changes. At any point, if there is an error, you should have a good idea where it is.
2. Use temporary variables to hold intermediate values so you can display and check them.
3. Once the program is working, you might want to remove some of the scaffolding or consolidate multiple statements into compound expressions, but only if it does not make the program difficult to read.

Exercise 15.3 Use incremental development to write a function called `hypotenuse` that returns the length of the hypotenuse of a right triangle given the lengths of the two legs as arguments. Record each stage of the development process as you go.

15.7 Composition

As you should expect by now, you can call one function from within another. This ability is called **composition**.

As an example, we'll write a function that takes two points, the center of the circle and a point on the perimeter, and computes the area of the circle.

Assume that the center point is stored in the variables `xc` and `yc`, and the perimeter point is in `xp` and `yp`. The first step is to find the radius of the circle, which is the distance between the two points. We just wrote a function, `distance`, that does that:

```
radius = distance(xc, yc, xp, yp)
```

The next step is to find the area of a circle with that radius; we just wrote that, too:

```
result = area(radius)
```

Encapsulating these steps in a function, we get:

```
def circle_area(xc, yc, xp, yp):
    radius = distance(xc, yc, xp, yp)
    result = area(radius)
    return result
```

The temporary variables `radius` and `result` are useful for development and debugging, but once the program is working, we can make it more concise by composing the function calls:

```
def circle_area(xc, yc, xp, yp):
    return area(distance(xc, yc, xp, yp))
```

15.8 Stack diagrams

To keep track of which variables can be used where, it is sometimes useful to draw a **stack diagram**. Like state diagrams, stack diagrams show the value of each variable, but they also show the function each variable belongs to.

Each function is represented by a **frame**. A frame is a box with the name of a function beside it and the parameters and variables of the function inside it. The stack diagram for the previous example looks like this:

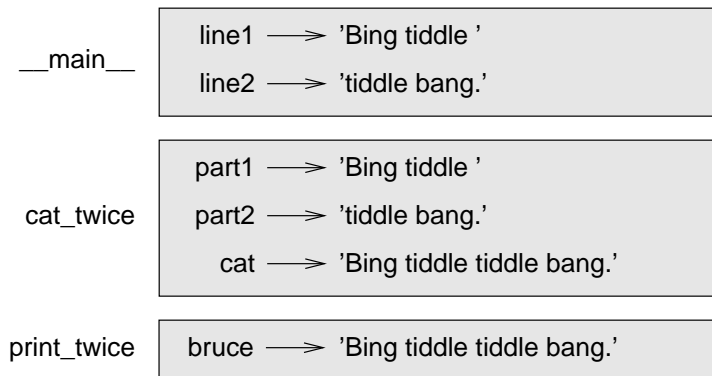

The frames are arranged in a stack that indicates which function called which, and so on. In this example, `print_twice` was called by `cat_twice`, and `cat_twice` was called by `__main__`, which is a special name for the topmost frame. When you create a variable outside of any function, it belongs to `__main__`.

Each parameter refers to the same value as its corresponding argument. So, `part1` has the same value as `line1`, `part2` has the same value as `line2`, and `bruce` has the same value as `cat`.

If an error occurs during a function call, Python prints the name of the function, and the name of the function that called it, and the name of the function that called *that*, all the way back to `__main__`.

For example, if you try to access `cat` from within `print_twice`, you get a `NameError`:

```

Traceback (innermost last):
  File "test.py", line 13, in __main__
    cat_twice(line1, line2)
  File "test.py", line 5, in cat_twice
    print_twice(cat)
  File "test.py", line 9, in print_twice
    print cat
NameError: name 'cat' is not defined

```

This list of functions is called a **traceback**. It tells you what program file the error occurred in, and what line, and what functions were executing at the time. It also shows the line of code that caused the error.

The order of the functions in the traceback is the same as the order of the frames in the stack diagram. The function that is currently running is at the bottom.

15.9 Boolean functions

Functions can return booleans, which is often convenient for hiding complicated tests inside functions. For example:

```
def is_divisible(x, y):
    if x % y == 0:
        return True
    else:
        return False
```

It is common to give boolean functions names that sound like yes/no questions; `is_divisible` returns either `True` or `False` to indicate whether `x` is divisible by `y`.

Here is an example:

```
>>> is_divisible(6, 4)
False
>>> is_divisible(6, 3)
True
```

The result of the `==` operator is a boolean, so we can write the function more concisely by returning it directly:

```
def is_divisible(x, y):
    return x % y == 0
```

Boolean functions are often used in conditional statements:

```
if is_divisible(x, y):
    print 'x is divisible by y'
```

It might be tempting to write something like:

```
if is_divisible(x, y) == True:
    print 'x is divisible by y'
```

But the extra comparison is unnecessary.

Exercise 15.4 Write a function `is_between(x, y, z)` that returns `True` if $x \leq y \leq z$ or `False` otherwise.

15.10 Optional parameters

We have seen built-in functions and methods that take a variable number of arguments. It is possible to write user-defined functions with optional arguments, too. For example, here is a function that prints the most common words in a histogram

```
def print_most_common(hist, num=10)
    t = most_common(hist)
    print 'The most common words are:'
    for freq, word in t[0:num]:
        print word, '\t', freq
```

The first parameter is required; the second is optional. The **default value** of num is 10.

If you only provide one argument:

```
print_most_common(hist)
```

num gets the default value. If you provide two arguments:

```
print_most_common(hist, 20)
```

num gets the value of the argument instead. In other words, the optional argument **overrides** the default value.

If a function has both required and optional parameters, all the required parameters have to come first, followed by the optional ones.

15.11 Debugging

Breaking a large program into smaller functions creates natural checkpoints for debugging. If a function is not working, there are three possibilities to consider:

- There is something wrong with the arguments the function is getting; a precondition is violated.
- There is something wrong with the function; a postcondition is violated.
- There is something wrong with the return value or the way it is being used.

To rule out the first possibility, you can add a `print` statement at the beginning of the function and display the values of the parameters (and maybe their types). Or you can write code that checks the preconditions explicitly.

If the parameters look good, add a `print` statement before each `return` statement that displays the return value. If possible, check the result by hand. Consider calling the function with values that make it easy to check the result (as in Section 15.6).

If the function seems to be working, look at the function call to make sure the return value is being used correctly (or used at all!).

Adding `print` statements at the beginning and end of a function can help make the flow of execution more visible.

If you are confused about the flow of execution, this kind of output can be helpful. It takes some time to develop effective scaffolding, but a little bit of scaffolding can save a lot of debugging.

15.12 Glossary

call graph: A diagram that shows every frame created during the execution of a program, with an arrow from each caller to each callee.

dead code: Part of a program that can never be executed, often because it appears after a return statement.

declaration: A statement like `global` that tells the interpreter something about a variable.

default value: The value given to an optional parameter if no argument is provided.

flag: A boolean variable used to indicate whether a condition is true.

frame: A box in a stack diagram that represents a function call. It contains the local variables and parameters of the function.

global variable: A variable defined outside a function. Global variables can be accessed from any function.

guardian: A programming pattern that uses a conditional statement to check for and handle circumstances that might cause an error.

incremental development: A program development plan intended to avoid debugging by adding and testing only a small amount of code at a time.

local variable: A variable defined inside a function. A local variable can only be used inside its function.

None: A special value returned by functions that have no return statement or a return statement without an argument.

override: To replace a default value with an argument.

scaffolding: Code that is used during program development but is not part of the final version.

stack diagram: A graphical representation of a stack of functions, their variables, and the values they refer to.

temporary variable: A variable used to store an intermediate value in a complex calculation.

traceback: A list of the functions that are executing, printed when an exception occurs.

15.13 Exercises

Exercise 15.5 Draw a stack diagram for the following program. What does the program print?

```
def b(z):
    prod = a(z, z)
    print z, prod
    return prod

def a(x, y):
    x = x + 1
    return x * y

def c(x, y, z):
    sum = x + y + z
    pow = b(sum)**2
    return pow

x = 1
y = x + 1
print c(x, y+3, x+y)
```

Exercise 15.6 A palindrome is a word that is spelled the same backward and forward, like “noon” and “redivider”. Recursively, a word is a palindrome if the first and last letters are the same and the middle is a palindrome.

The following are functions that take a string argument and return the first, last, and middle letters:

```
def first(word):
    return word[0]

def last(word):
    return word[-1]

def middle(word):
    return word[1:-1]
```

We’ll see how they work in Chapter 6.

1. Type these functions into a file named `palindrome.py` and test them out. What happens if you call `middle` with a string with two letters? One letter? What about the empty string, which is written `''` and contains no letters?
2. Write a function called `is_palindrome` that takes a string argument and returns `True` if it is a palindrome and `False` otherwise. Remember that you can use the built-in function `len` to check the length of a string.

Exercise 15.7 A number, a , is a power of b if it is divisible by b and a/b is a power of b . Write a function called `is_power` that takes parameters a and b and returns `True` if a is a power of b .

Exercise 15.8 The greatest common divisor (GCD) of a and b is the largest number that divides both of them with no remainder¹.

One way to find the GCD of two numbers is Euclid's algorithm, which is based on the observation that if r is the remainder when a is divided by b , then $\text{gcd}(a, b) = \text{gcd}(b, r)$. As a base case, we can consider $\text{gcd}(a, 0) = a$.

Write a function called `gcd` that takes parameters a and b and returns their greatest common divisor. If you need help, see wikipedia.org/wiki/Euclidean_algorithm.

¹This exercise is based on an example from Abelson and Sussman's *Structure and Interpretation of Computer Programs*.

Appendix A

Debugging

Different kinds of errors can occur in a program, and it is useful to distinguish among them in order to track them down more quickly:

- Syntax errors are produced by Python when it is translating the source code into byte code. They usually indicate that there is something wrong with the syntax of the program. Example: Omitting the colon at the end of a `def` statement yields the somewhat redundant message `SyntaxError: invalid syntax`.
- Runtime errors are produced by the interpreter if something goes wrong while the program is running. Most runtime error messages include information about where the error occurred and what functions were executing.
- Semantic errors are problems with a program that runs without producing error messages but doesn't do the right thing. Example: An expression may not be evaluated in the order you expect, yielding an incorrect result.

The first step in debugging is to figure out which kind of error you are dealing with. Although the following sections are organized by error type, some techniques are applicable in more than one situation.

A.1 Syntax errors

Syntax errors are usually easy to fix once you figure out what they are. Unfortunately, the error messages are often not helpful. The most common messages are `SyntaxError: invalid syntax` and `SyntaxError: invalid token`, neither of which is very informative.

On the other hand, the message does tell you where in the program the problem occurred. Actually, it tells you where Python noticed a problem, which is not necessarily where the

error is. Sometimes the error is prior to the location of the error message, often on the preceding line.

If you are building the program incrementally, you should have a good idea about where the error is. It will be in the last line you added.

If you are copying code from a book, start by comparing your code to the book's code very carefully. Check every character. At the same time, remember that the book might be wrong, so if you see something that looks like a syntax error, it might be.

Here are some ways to avoid the most common syntax errors:

1. Make sure you are not using a Python keyword for a variable name.
2. Check that you have a colon at the end of the header of every compound statement, including `for`, `while`, `if`, and `def` statements.
3. Make sure that any strings in the code have matching quotation marks.
4. If you have multiline strings with triple quotes (single or double), make sure you have terminated the string properly. An unterminated string may cause an `invalid token` error at the end of your program, or it may treat the following part of the program as a string until it comes to the next string. In the second case, it might not produce an error message at all!
5. An unclosed opening operator—`(`, `{`, or `[`—makes Python continue with the next line as part of the current statement. Generally, an error occurs almost immediately in the next line.
6. Check for the classic `=` instead of `==` inside a conditional.
7. Check the indentation to make sure it lines up the way it is supposed to. Python can handle space and tabs, but if you mix them it can cause problems. The best way to avoid this problem is to use a text editor that knows about Python and generates consistent indentation.

If nothing works, move on to the next section...

A.1.1 I keep making changes and it makes no difference.

If the interpreter says there is an error and you don't see it, that might be because you and the interpreter are not looking at the same code. Check your programming environment to make sure that the program you are editing is the one Python is trying to run.

If you are not sure, try putting an obvious and deliberate syntax error at the beginning of the program. Now run it again. If the interpreter doesn't find the new error, you are not running the new code.

There are a few likely culprits:

- You edited the file and forgot to save the changes before running it again. Some programming environments do this for you, but some don't.
- You changed the name of the file, but you are still running the old name.
- Something in your development environment is configured incorrectly.
- If you are writing a module and using `import`, make sure you don't give your module the same name as one of the standard Python modules.
- If you are using `import` to read a module, remember that you have to restart the interpreter or use `reload` to read a modified file. If you import the module again, it doesn't do anything.

If you get stuck and you can't figure out what is going on, one approach is to start again with a new program like "Hello, World!," and make sure you can get a known program to run. Then gradually add the pieces of the original program to the new one.

A.2 Runtime errors

Once your program is syntactically correct, Python can compile it and at least start running it. What could possibly go wrong?

A.2.1 My program does absolutely nothing.

This problem is most common when your file consists of functions and classes but does not actually invoke anything to start execution. This may be intentional if you only plan to import this module to supply classes and functions.

If it is not intentional, make sure that you are invoking a function to start execution, or execute one from the interactive prompt. Also see the "Flow of Execution" section below.

A.2.2 My program hangs.

If a program stops and seems to be doing nothing, it is "hanging." Often that means that it is caught in an infinite loop. If there is a particular loop that you suspect is the problem, add a `print` statement immediately before the loop that says "entering the loop" and another immediately after that says "exiting the loop."

Run the program. If you get the first message and not the second, you've got an infinite loop. If you think you have an infinite loop and you think you know what loop is causing the problem, add a `print` statement inside the loop as the last statement in the loop loop that prints the values of the variables in the condition and the value of the condition.

For example:

```
while x > 0 and y < 0 :
    # do something to x
    # do something to y

    print 'x: ', x
    print 'y: ', y
    print 'condition: ', (x > 0 and y < 0)
```

Now when you run the program, you will see three lines of output for each time through the loop. The last time through the loop, the condition should be false. If the loop keeps going, you will be able to see the values of `x` and `y`, and you might figure out why they are not being updated correctly.

Flow of Execution

If you are not sure how the flow of execution is moving through your program, add `print` statements to the beginning of each function with a message like “entering function `foo`,” where `foo` is the name of the function.

Now when you run the program, it will print a trace of each function as it is invoked.

A.2.3 When I run the program I get an exception.

If something goes wrong during runtime, Python prints a message that includes the name of the exception, the line of the program where the problem occurred, and a traceback.

The traceback identifies the function that is currently running, and then the function that invoked it, and then the function that invoked *that*, and so on. In other words, it traces the sequence of function invocations that got you to where you are. It also includes the line number in your file where each of these calls occurs.

The first step is to examine the place in the program where the error occurred and see if you can figure out what happened. These are some of the most common runtime errors:

NameError: You are trying to use a variable that doesn’t exist in the current environment. Remember that local variables are local. You cannot refer to them from outside the function where they are defined.

TypeError: There are several possible causes:

- You are trying to use a value improperly. Example: indexing a string, list, or tuple with something other than an integer.
- There is a mismatch between the items in a format string and the items passed for conversion. This can happen if either the number of items does not match or an invalid conversion is called for.

- You are passing the wrong number of arguments to a function or method. For methods, look at the method definition and check that the first parameter is `self`. Then look at the method invocation; make sure you are invoking the method on an object with the right type and providing the other arguments correctly.

KeyError: You are trying to access an element of a dictionary using a key that the dictionary does not contain.

AttributeError: You are trying to access an attribute or method that does not exist. Check the spelling! You can use `dir` to list the attributes that do exist.

If an `AttributeError` indicates that an object has `NoneType`, that means that it is `None`. One common cause is forgetting to return a value from a function; if you get to the end of a function without hitting a `return` statement, it returns `None`. Another common cause is using the result from a list method, like `sort`, that returns `None`.

IndexError: The index you are using to access a list, string, or tuple is greater than its length minus one. Immediately before the site of the error, add a `print` statement to display the value of the index and the length of the array. Is the array the right size? Is the index the right value?

The Python debugger (`pdb`) is useful for tracking down Exceptions because it allows you to examine the state of the program immediately before the error. You can read about `pdb` at docs.python.org/lib/module-pdb.html.

A.2.4 I added so many print statements I get inundated with output.

One of the problems with using `print` statements for debugging is that you can end up buried in output. There are two ways to proceed: simplify the output or simplify the program.

To simplify the output, you can remove or comment out `print` statements that aren't helping, or combine them, or format the output so it is easier to understand.

To simplify the program, there are several things you can do. First, scale down the problem the program is working on. For example, if you are searching a list, search a *small* list. If the program takes input from the user, give it the simplest input that causes the problem.

Second, clean up the program. Remove dead code and reorganize the program to make it as easy to read as possible. For example, if you suspect that the problem is in a deeply nested part of the program, try rewriting that part with simpler structure. If you suspect a large function, try splitting it into smaller functions and testing them separately.

Often the process of finding the minimal test case leads you to the bug. If you find that a program works in one situation but not in another, that gives you a clue about what is going on.

Similarly, rewriting a piece of code can help you find subtle bugs. If you make a change that you think shouldn't affect the program, and it does, that can tip you off.

A.3 Semantic errors

In some ways, semantic errors are the hardest to debug, because the interpreter provides no information about what is wrong. Only you know what the program is supposed to do.

The first step is to make a connection between the program text and the behavior you are seeing. You need a hypothesis about what the program is actually doing. One of the things that makes that hard is that computers run so fast.

You will often wish that you could slow the program down to human speed, and with some debuggers you can. But the time it takes to insert a few well-placed `print` statements is often short compared to setting up the debugger, inserting and removing breakpoints, and “stepping” the program to where the error is occurring.

A.3.1 My program doesn’t work.

You should ask yourself these questions:

- Is there something the program was supposed to do but which doesn’t seem to be happening? Find the section of the code that performs that function and make sure it is executing when you think it should.
- Is something happening that shouldn’t? Find code in your program that performs that function and see if it is executing when it shouldn’t.
- Is a section of code producing an effect that is not what you expected? Make sure that you understand the code in question, especially if it involves invocations to functions or methods in other Python modules. Read the documentation for the functions you invoke. Try them out by writing simple test cases and checking the results.

In order to program, you need to have a mental model of how programs work. If you write a program that doesn’t do what you expect, very often the problem is not in the program; it’s in your mental model.

The best way to correct your mental model is to break the program into its components (usually the functions and methods) and test each component independently. Once you find the discrepancy between your model and reality, you can solve the problem.

Of course, you should be building and testing components as you develop the program. If you encounter a problem, there should be only a small amount of new code that is not known to be correct.

A.3.2 I’ve got a big hairy expression and it doesn’t do what I expect.

Writing complex expressions is fine as long as they are readable, but they can be hard to debug. It is often a good idea to break a complex expression into a series of assignments to temporary variables.

For example:

```
self.hands[i].addCard(self.hands[self.findNeighbor(i)].popCard())
```

This can be rewritten as:

```
neighbor = self.findNeighbor(i)
pickedCard = self.hands[neighbor].popCard()
self.hands[i].addCard(pickedCard)
```

The explicit version is easier to read because the variable names provide additional documentation, and it is easier to debug because you can check the types of the intermediate variables and display their values.

Another problem that can occur with big expressions is that the order of evaluation may not be what you expect. For example, if you are translating the expression $\frac{x}{2\pi}$ into Python, you might write:

```
y = x / 2 * math.pi
```

That is not correct because multiplication and division have the same precedence and are evaluated from left to right. So this expression computes $x\pi/2$.

A good way to debug expressions is to add parentheses to make the order of evaluation explicit:

```
y = x / (2 * math.pi)
```

Whenever you are not sure of the order of evaluation, use parentheses. Not only will the program be correct (in the sense of doing what you intended), it will also be more readable for other people who haven't memorized the rules of precedence.

A.3.3 I've got a function or method that doesn't return what I expect.

If you have a return statement with a complex expression, you don't have a chance to print the return value before returning. Again, you can use a temporary variable. For example, instead of:

```
return self.hands[i].removeMatches()
```

you could write:

```
count = self.hands[i].removeMatches()
return count
```

Now you have the opportunity to display the value of count before returning.

A.3.4 I'm really, really stuck and I need help.

First, try getting away from the computer for a few minutes. Computers emit waves that affect the brain, causing these symptoms:

- Frustration and rage.
- Superstitious beliefs (“the computer hates me”) and magical thinking (“the program only works when I wear my hat backward”).
- Random walk programming (the attempt to program by writing every possible program and choosing the one that does the right thing).

If you find yourself suffering from any of these symptoms, get up and go for a walk. When you are calm, think about the program. What is it doing? What are some possible causes of that behavior? When was the last time you had a working program, and what did you do next?

Sometimes it just takes time to find a bug. I often find bugs when I am away from the computer and let my mind wander. Some of the best places to find bugs are trains, showers, and in bed, just before you fall asleep.

A.3.5 No, I really need help.

It happens. Even the best programmers occasionally get stuck. Sometimes you work on a program so long that you can’t see the error. A fresh pair of eyes is just the thing.

Before you bring someone else in, make sure you are prepared. Your program should be as simple as possible, and you should be working on the smallest input that causes the error. You should have `print` statements in the appropriate places (and the output they produce should be comprehensible). You should understand the problem well enough to describe it concisely.

When you bring someone in to help, be sure to give them the information they need:

- If there is an error message, what is it and what part of the program does it indicate?
- What was the last thing you did before this error occurred? What were the last lines of code that you wrote, or what is the new test case that fails?
- What have you tried so far, and what have you learned?

When you find the bug, take a second to think about what you could have done to find it faster. Next time you see something similar, you will be able to find the bug more quickly.

Remember, the goal is not just to make the program work. The goal is to learn how to make the program work.

Appendix B

Contributor List

Contributor List for “Python for Informatics”

Bruce Shields for copy editing early drafts, Sarah Hegge, Steven Cherry, Sarah Kathleen Barbarow, Andrea Parker, Radaphat Chongthammakun, Megan Hixon, Kirby Urner, Sarah Kathleen Barbrow, Katie Kujala, Noah Botimer, Emily Alinder, Mark Thompson-Kular, James Perry,

Contributor List for “Think Python”

(Allen B. Downey)

More than 100 sharp-eyed and thoughtful readers have sent in suggestions and corrections over the past few years. Their contributions, and enthusiasm for this project, have been a huge help.

For the detail on the nature of each of the contributions from these individuals, see the “Think Python” text.

Lloyd Hugh Allen, Yvon Boulianne, Fred Bremmer, Jonah Cohen, Michael Conlon, Benoit Girard, Courtney Gleason and Katherine Smith, Lee Harr, James Kaylin, David Kershaw, Eddie Lam, Man-Yong Lee, David Mayo, Chris McAloon, Matthew J. Moelter, Simon Dicon Montford, John Ouzts, Kevin Parks, David Pool, Michael Schmitt, Robin Shaw, Paul Sleigh, Craig T. Snyder, Ian Thomas, Keith Verheyden, Peter Winstanley, Chris Wrobel, Moshe Zadka, Christoph Zwerschke, James Mayer, Hayden McAfee, Angel Arnal, Tauhidul Hoque and Lex Berezhny, Dr. Michele Alzetta, Andy Mitchell, Kalin Harvey, Christopher P. Smith, David Hutchins, Gregor Lingl, Julie Peters, Florin Oprina, D. J. Webre, Ken, Ivo Wever, Curtis Yanko, Ben Logan, Jason Armstrong, Louis Cordier, Brian Cain, Rob Black, Jean-Philippe Rey at Ecole Centrale Paris, Jason Mader at George Washington University made a number Jan Gundtofte-Bruun, Abel David and Alexis Dinno,

Charles Thayer, Roger Sperberg, Sam Bull, Andrew Cheung, C. Corey Capel, Alessandra, Wim Champagne, Douglas Wright, Jared Spindor, Lin Peiheng, Ray Hagtvedt, Torsten Hübsch, Inga Petuhhov, Arne Babenhauserheide, Mark E. Casida, Scott Tyler, Gordon Shephard, Andrew Turner, Adam Hobart, Daryl Hammond and Sarah Zimmerman, George Sass, Brian Bingham, Leah Engelbert-Fenton, Joe Funke, Chao-chao Chen, Jeff Paine, Lubos Pintes, Gregg Lind and Abigail Heithoff, Max Hailperin, Chotipat Pornavalai, Stanislaw Antol, Eric Pashman, Miguel Azevedo, Jianhua Liu, Nick King, Martin Zuther, Adam Zimmerman, Ratnakar Tiwari, Anurag Goel, Kelli Kratzer, Mark Griffiths, Roydan Ongie, Patryk Wolowiec, Mark Chonofsky, Russell Coleman, Wei Huang, Karen Barber, Nam Nguyen, Stéphane Morin, and Paul Stoop.

Index

- abecedarian, 63
- abs function, 178
- absolute path, 128
- access, 90
- accumulator, 60
 - sum, 57
- algorithm, 7, 13
 - Euclid, 190
 - MD5, 137
- aliasing, 96, 97, 103
 - copying to avoid, 100
- alternative execution, 31
- ambiguity, 10
- and operator, 30
- API, 153
- append method, 92, 98
- argument, 39, 43, 46, 49, 97
 - gather, 179
 - keyword, 117
 - list, 97
 - optional, 68, 94
 - variable-length tuple, 179
- argument scatter, 179
- arguments, 133
- arithmetic operator, 18
- assignment, 25, 89
 - item, 64, 90, 116
 - multiple, 59, 181
 - tuple, 117, 124, 178
- assignment statement, 16
- attribute, 175
- AttributeError, 195

- BeautifulSoup, 143, 144
- big, hairy expression, 196
- bisection, debugging by, 59
- bitwise operator, 18

- body, 36, 43, 49, 52
- bool type, 29
- boolean expression, 29, 36
- boolean function, 186
- boolean operator, 66
- bracket
 - squiggly, 105
- bracket operator, 61, 90, 116
- branch, 31, 36
- break statement, 53
- bug, 7, 13
- BY-SA, v

- calculator, 14
- call graph, 188
- case-sensitivity, variable names, 25
- catch, 86
- CC-BY-SA, v
- celsius, 33
- central processing unit, 12
- chained conditional, 31, 36
- character, 61
- checksum, 136, 137
- choice function, 41
- close method, 85, 135
- Collatz conjecture, 53
- colon, 43, 192
- comment, 22, 26
- commutativity, 21
- comparable, 115, 124
- compare function, 178
- comparison
 - string, 66
 - tuple, 116
- comparison operator, 29
- compile, 5, 12
- composition, 46, 50, 184

- compound statement, 30, 36
- concatenation, 21, 26, 63, 64, 95, 180
 - list, 91, 98
- condition, 30, 36, 52, 193
- conditional, 192
 - chained, 31, 36
 - nested, 32, 37
- conditional execution, 30
- conditional statement, 30, 36, 186
- connect function, 157
- consistency check, 112
- constraint, 175
- continue statement, 55
- contributors, 199
- conversion
 - type, 40
- copy
 - slice, 64, 92
 - to avoid aliasing, 100
- count method, 68
- counter, 60, 65, 73, 80, 107, 181
- counting and looping, 65
- CPU, 12
- Creative Commons License, v
- cursor, 175
- cursor function, 157

- data structure, 123, 125
- database, 155
 - indexes, 155
- database browser, 175
- database normalization, 175
- dead code, 178, 188, 195
- debugger (pdb), 195
- debugging, 7, 11, 13, 24, 35, 49, 70, 86, 99, 112, 123, 187, 191
 - by bisection, 59
 - emotional response, 11, 198
 - experimental, 8
 - superstition, 198
- declaration, 181, 188
- decorate-sort-undecorate pattern, 117
- decrement, 51, 59
- def keyword, 43
- default value, 42, 187, 188
- definition
 - function, 43
- del operator, 93
- deletion, element of list, 93
- delimiter, 94, 103
- deterministic, 41, 42
- development plan
 - incremental, 182, 192
 - random walk programming, 124, 198
- diagram
 - call graph, 188
 - stack, 98, 185
 - state, 16, 72, 90, 96, 97, 122
- dict function, 105
- dictionary, 105, 113, 119, 195
 - looping with, 109
 - traversal, 119
- directory, 127
 - current, 136
 - cwd, 136
 - working, 128, 136
- divisibility, 20
- division
 - floating-point, 19
 - floor, 19, 36
- divmod, 178
- documentation, 13
- dot notation, 42, 50, 67
- Doyle, Arthur Conan, 8
- DSU pattern, 117, 125
- duplicate, 137

- element, 89, 102
- element deletion, 93
- ElementTree, 147, 153
 - find, 147
 - findall, 148
 - fromstring, 147
 - get, 148
- elif keyword, 31
- ellipses, 44
- else keyword, 31
- email address, 118
- emotional debugging, 11, 198
- empty list, 89
- empty string, 73, 95
- encapsulation, 65, 184

- end of line character, 86
- equivalence, 96
- equivalent, 102
- error
 - compile-time, 191
 - runtime, 8, 24, 35, 191
 - semantic, 8, 16, 25, 72, 191, 196
 - shape, 123
 - syntax, 7, 24, 191
- error message, 7, 8, 11, 16, 24, 191
- Euclid's algorithm, 190
- evaluate, 19
- exception, 8, 13, 24, 191, 194
 - AttributeError, 195
 - IndexError, 62, 72, 91, 195
 - IOError, 84
 - KeyError, 106, 195
 - NameError, 180, 194
 - OverflowError, 36
 - TypeError, 61, 64, 70, 116, 179, 194
 - UnboundLocalError, 181
 - ValueError, 22, 118
- executable, 6, 12
- exists function, 128
- experimental debugging, 8, 124
- expression, 18, 19, 26
 - big and hairy, 196
 - boolean, 29, 36
- extend method, 93
- eXtensible Markup Language, 154

- fahrenheit, 33
- False special value, 29
- file, 77
 - open, 78
 - reading, 80
 - writing, 85
- file handle, 78
- file name, 127
- filter pattern, 81
- find function, 65
- flag, 73, 180, 188
- float function, 40
- float type, 15
- floating-point, 25
- floating-point division, 19
- floor division, 19, 26, 36
- flow of execution, 45, 50, 52, 187, 194
- folder, 127
- for loop, 62, 91
- for statement, 55
- foreign key, 175
- formal language, 9, 13
- format operator, 69, 73, 194
- format sequence, 69, 73
- format string, 69, 73
- frame, 185, 188
- Free Documentation License, GNU, vii, viii
- frequency, 107
 - letter, 126
- fruitful function, 47, 49
- frustration, 198
- function, 43, 49
 - abs, 178
 - choice, 41
 - compare, 178
 - connect, 157
 - cursor, 157
 - dict, 105
 - exists, 128
 - find, 65
 - float, 40
 - getcwd, 127
 - int, 40
 - len, 62, 106
 - list, 94
 - log, 43
 - max, 179, 180
 - min, 179, 180
 - open, 78, 84
 - popen, 135
 - randint, 41
 - random, 41
 - raw_input, 21
 - reload, 193
 - repr, 86
 - reversed, 123
 - sorted, 123
 - sqrt, 43, 183
 - str, 40
 - sum, 180

- tuple, 115
- function argument, 46
- function call, 39, 49
- function composition, 184
- function definition, 43, 45, 49
- function frame, 185, 188
- function object, 44
- function parameter, 46
- function, fruitful, 47
- function, math, 42
- function, reasons for, 48
- function, trigonometric, 43
- function, tuple as return value, 178
- function, void, 47

- gather, 125, 179
- GCD (greatest common divisor), 190
- get method, 108
- getcwd function, 127
- global statement, 181
- global variable, 180, 188
 - update, 181
- GNU Free Documentation License, vii, viii
- greatest common divisor (GCD), 190
- guardian pattern, 34, 37, 71, 72, 188

- hanging, 193
- hardware, 3
 - architecture, 3
- hash function, 113
- hashable, 115, 121, 124
- hashing, 136
- hashtable, 106, 113
- header, 43, 49, 192
- Hello, World, 11
- help utility, 13
- high-level language, 5, 12
- histogram, 107, 113
- Holmes, Sherlock, 8
- HTML, 143
- hypotenuse, 184

- identical, 102
- identity, 96
- if statement, 30
- immutability, 64, 73, 97, 115, 122

- implementation, 107, 113
- import statement, 49
- in operator, 66, 91, 106
- increment, 51, 59
- incremental development, 188, 192
- indentation, 43, 192
- index, 61, 72, 73, 90, 102, 105, 175, 194
 - looping with, 91
 - negative, 62
 - slice, 63, 92
 - starting at zero, 61, 90
- IndexError, 62, 72, 91, 195
- infinite loop, 52, 60, 193
- initialization (before update), 51
- int function, 40
- int type, 15
- integer, 25
- interactive mode, 6, 12, 18, 47
- interpret, 5, 12
- invocation, 67, 73
- IOError, 84
- is operator, 96
- item, 73, 89
 - dictionary, 113
- item assignment, 64, 90, 116
- item update, 91
- items method, 119
- iteration, 51, 59

- join method, 95

- key, 105, 113
- key-value pair, 105, 113, 119
- keyboard input, 21
- KeyError, 106, 195
- keys method, 110
- keyword, 17, 25, 192
 - def, 43
 - elif, 31
 - else, 31
- keyword argument, 117

- language
 - formal, 9
 - high-level, 5
 - low-level, 5

- natural, 9
- programming, 5
- safe, 8
- len function, 62, 106
- letter frequency, 126
- letter rotation, 75
- Linux, 9
- list, 89, 94, 102, 122
 - as argument, 97
 - concatenation, 91, 98
 - copy, 92
 - element, 90
 - empty, 89
 - function, 94
 - index, 91
 - membership, 91
 - method, 92
 - nested, 89, 91
 - operation, 91
 - repetition, 92
 - slice, 92
 - traversal, 91, 102
- literalness, 10
- local variable, 180, 188
- log function, 43
- logical key, 175
- logical operator, 29, 30
- lookup, 113
- loop, 52
 - condition, 193
 - for, 62, 91
 - infinite, 52, 193
 - maximum, 57
 - minimum, 57
 - nested, 108, 113
 - traversal, 62
 - while, 51
- looping
 - with dictionaries, 109
 - with indices, 91
 - with strings, 65
- looping and counting, 65
- low-level language, 5, 12
- ls (Unix command), 135
- machine code, 12
- main memory, 12
- mapping, 90
- math function, 42
- max function, 179, 180
- McCloskey, Robert, 63
- MD5 algorithm, 137
- membership
 - dictionary, 106
 - list, 91
 - set, 106
- mental model, 196
- method, 67, 73
 - append, 92, 98
 - close, 85, 135
 - count, 68
 - extend, 93
 - get, 108
 - items, 119
 - join, 95
 - keys, 110
 - pop, 93
 - read, 135
 - readline, 135
 - remove, 93
 - sort, 93, 99, 116
 - split, 94, 118
 - string, 74
 - values, 106
 - void, 93
- method, list, 92
- min function, 179, 180
- mnemonic, 23, 25
- model, mental, 196
- module, 42, 50
 - os, 127
 - random, 41
 - reload, 193
 - sqlite3, 156
- module object, 42
- modulus operator, 20, 26
- MP3, 136
- multiline string, 192
- multiple assignment, 59, 181
- mutability, 64, 90, 92, 97, 115, 122, 182
- NameError, 180, 194

- natural language, 9, 13
- negative index, 62
- nested conditional, 32, 37
- nested list, 89, 91, 102
- nested loops, 108, 113
- newline, 21, 79, 85, 86
- None special value, 47, 57, 93, 94, 178, 188
- normalization, 175
- not operator, 30
- number, random, 41

- object, 64, 73, 96, 102
 - function, 44
- object code, 6, 12
- open function, 78, 84
- operand, 18, 26
- operator, 25
 - and, 30
 - bitwise, 18
 - boolean, 66
 - bracket, 61, 90, 116
 - comparison, 29
 - del, 93
 - format, 69, 73, 194
 - in, 66, 91, 106
 - is, 96
 - logical, 29, 30
 - modulus, 20, 26
 - not, 30
 - or, 30
 - slice, 63, 74, 92, 98, 116
 - string, 21
- operator, arithmetic, 18
- optional argument, 68, 94
- optional parameter, 41, 186
- or operator, 30
- order of operations, 20, 25, 197
- os module, 127
- OverflowError, 36
- override, 42, 187, 188

- palindrome, 189
- parameter, 46, 49, 97, 180
 - gather, 179
 - optional, 41, 186
- parentheses
 - argument in, 39
 - empty, 43, 67
 - matching, 7
 - overriding precedence, 20
 - parameters in, 46, 180
 - tuples in, 115
- parse, 9, 13
- parsing
 - HTML, 143
- pass statement, 30
- path, 127
 - absolute, 128, 135
 - relative, 128, 136
- pattern
 - decorate-sort-undecorate, 117
 - DSU, 117
 - filter, 81
 - guardian, 34, 37, 71, 72, 188
 - search, 65, 73
 - swap, 117
- pdb (Python debugger), 195
- PEMDAS, 20
- persistence, 77
- pi, 43
- pipe, 135, 136
- poetry, 10
- pop method, 93
- popen function, 135
- port, 144
- portability, 5, 12
- postcondition, 187
- precedence, 26, 197
- precondition, 187
- primary key, 175
- print statement, 11, 13, 195
- problem solving, 4, 12
- program, 7, 13
- programming language, 5
- prompt, 6, 12, 21
- prose, 10
- pseudorandom, 41, 42
- Pythagorean theorem, 182
- Python 3.0, 11, 19, 21
- Python debugger (pdb), 195
- python.org, 13

- Pythonic, 85, 86
- QA, 84, 86
- Quality Assurance, 84, 86
- quotation mark, 11, 15, 16, 64, 192
- radian, 43
- rage, 198
- randint function, 41
- random function, 41
- random module, 41
- random number, 41
- random walk programming, 124, 198
- raw_input function, 21
- read method, 135
- readline method, 135
- redundancy, 10
- reference, 97, 103
 - aliasing, 97
- relation, 175
- relative path, 128
- reload function, 193
- remove method, 93
- repetition
 - list, 92
- repr function, 86
- return statement, 177, 197
- return value, 39, 49, 177
 - tuple, 178
- reversed function, 123
- rotation, letter, 75
- rules of precedence, 20, 26
- running pace, 14
- runtime error, 8, 24, 35, 191, 194
- safe language, 8
- sanity check, 112
- scaffolding, 112, 183, 188
- scatter, 125, 179
- script, 6, 12
- script mode, 6, 12, 18, 47
- search pattern, 65, 73
- secondary memory, 12, 77
- semantic error, 8, 13, 16, 25, 72, 191, 196
- semantics, 8, 13
- sequence, 61, 73, 89, 94, 115, 122
- Service Oriented Architecture, 154
- set membership, 106
- shape, 125
- shape error, 123
- shell, 135, 136
- short circuit, 34, 37
- sine function, 43
- singleton, 115, 124
- slice, 73
 - copy, 64, 92
 - list, 92
 - string, 63
 - tuple, 116
 - update, 92
- slice operator, 63, 74, 92, 98, 116
- SOA, 154
- socket, 144
- sort method, 93, 99, 116
- sorted function, 123
- source code, 6, 12
- special value
 - False, 29
 - None, 47, 57, 93, 94, 178, 188
 - True, 29
- spider, 144
- split method, 94, 118
- sqlite3 module, 156
- sqrt, 183
- sqrt function, 43
- squiggly bracket, 105
- stack diagram, 98, 185, 188, 189
- state diagram, 16, 25, 72, 90, 96, 97, 122
- statement, 18, 25
 - assignment, 16
 - break, 53
 - compound, 30
 - conditional, 30, 36, 186
 - continue, 55
 - for, 55, 62, 91
 - global, 181
 - if, 30
 - import, 49
 - pass, 30
 - print, 11, 13, 195
 - return, 177, 197

- try, 84
 - while, 51
- step size, 74
- str function, 40
- string, 15, 25, 94, 122
 - comparison, 66
 - empty, 95
 - immutable, 64
 - method, 67
 - multiline, 192
 - operation, 21
 - slice, 63
- string method, 74
- string representation, 86
- string type, 15
- structure, 9
- sum function, 180
- superstitious debugging, 198
- swap pattern, 117
- syntax, 7, 13, 192
- syntax error, 7, 13, 24, 191

- temperature conversion, 33
- temporary variable, 177, 188, 197
- test case, minimal, 195
- testing
 - incremental development, 182
 - interactive mode, 6
 - knowing the answer, 183
 - minimal test case, 195
- text file, 86
- token, 9, 13
- traceback, 33, 35, 37, 185, 188, 194
- traversal, 62, 65, 71, 73, 107, 109, 117
 - list, 91
- traverse
 - dictionary, 119
- trigonometric function, 43
- True special value, 29
- try statement, 84
- tuple, 115, 122, 124, 175, 178
 - as key in dictionary, 121
 - assignment, 117
 - comparison, 116
 - in brackets, 122
 - singleton, 115
 - slice, 116
- tuple assignment, 124, 178
- tuple function, 115
- type, 15, 25
 - bool, 29
 - dict, 105
 - file, 77
 - float, 15
 - int, 15
 - list, 89
 - str, 15
 - tuple, 115
- type conversion, 40
- TypeError, 61, 64, 70, 116, 179, 194
- typographical error, 124

- UnboundLocalError, 181
- underscore character, 17
- Unicode, 158
- Unix command
 - ls, 135
- update, 51, 59
 - global variable, 181
 - item, 91
 - slice, 92
- use before def, 24, 45

- value, 15, 25, 96, 113
 - default, 42, 187
 - tuple, 178
- ValueError, 22, 118
- values method, 106
- variable, 16, 25
 - global, 180
 - local, 180
 - temporary, 177, 188, 197
 - updating, 51
- variable-length argument tuple, 179
- void function, 47, 49
- void method, 93

- walk, 136
- while loop, 51
- whitespace, 35, 49, 86, 192
- working directory, 128

- XML, 154

zero, index starting at, 61, 90

